

The ARM Instruction Set Architecture

Mark McDermott

With help from our good friends at ARM

Fall 2008



Main features of the ARM Instruction Set

- All instructions are 32 bits long.
- Most instructions execute in a single cycle.
- Most instructions can be conditionally executed.
- A load/store architecture
 - Data processing instructions act only on registers
 - Three operand format
 - Combined ALU and shifter for high speed bit manipulation
 - Specific memory access instructions with powerful auto-indexing addressing modes.
 - 32 bit and 8 bit data types
 - and also 16 bit data types on ARM Architecture v4.
 - Flexible multiple register load and store instructions
- Instruction set extension via coprocessors
- Very dense 16-bit compressed instruction set (Thumb)

Coprocessors

- Up to **16** coprocessors can be defined
- Expands the ARM instruction set
- Each coprocessor can have up to 16 private registers of any reasonable size
- Load-store architecture

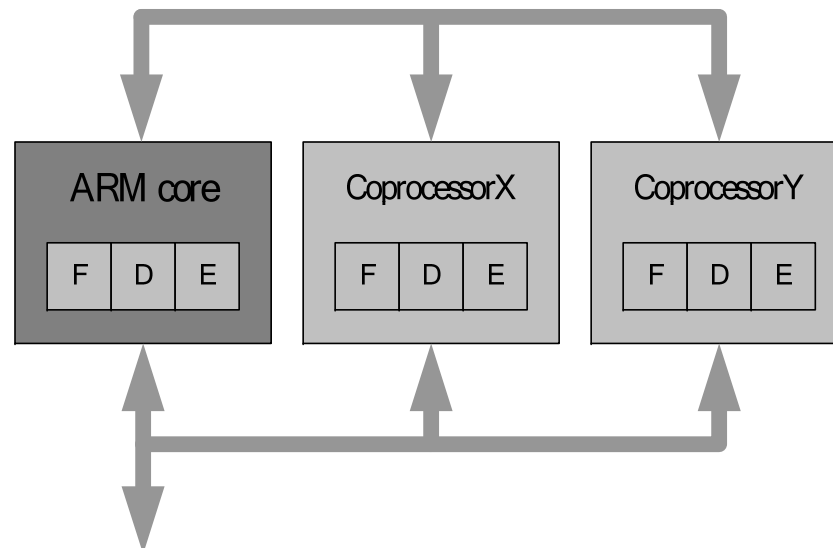

Thumb

- **Thumb is a 16-bit instruction set**
 - Optimized for code density from C code
 - Improved performance form narrow memory
 - Subset of the functionality of the ARM instruction set
- **Core has two execution states – ARM and Thumb**
 - Switch between them using BX instruction
- **Thumb has characteristic features:**
 - Most Thumb instruction are executed unconditionally
 - Many Thumb data process instruction use a 2-address format
 - Thumb instruction formats are less regular than ARM instruction formats, as a result of the dense encoding.

Processor Modes

- **The ARM has six operating modes:**

- User (unprivileged mode under which most tasks run)

- FIQ (entered when a high priority (fast) interrupt is raised)

- IRQ (entered when a low priority (normal) interrupt is raised)

- Supervisor (entered on reset and when a Software Interrupt instruction is executed)

- Abort (used to handle memory access violations)

- Undef (used to handle undefined instructions)

- **ARM Architecture Version 4 adds a seventh mode:**

- System (privileged mode using the same registers as user mode)

The Registers

- **ARM has 37 registers in total, all of which are 32-bits long.**
 - 1 dedicated program counter
 - 1 dedicated current program status register
 - 5 dedicated saved program status registers
 - 30 general purpose registers
- **However these are arranged into several banks, with the accessible bank being governed by the processor mode. Each mode can access**
 - a particular set of r0-r12 registers
 - a particular r13 (the stack pointer) and r14 (link register)
 - r15 (the program counter)
 - cpsr (the current program status register)
- **And privileged modes can also access**
 - a particular spsr (saved program status register)

The ARM Register Set

Current Visible Registers

Abort Mode	r0
	r1
	r2
	r3
	r4
	r5
	r6
	r7
	r8
	r9
	r10
	r11
	r12
	r13 (sp)
	r14 (lr)
r15 (pc)	
cpsr	
spsr	

Banked out Registers

User	FIQ	IRQ	SVC	Undef
	r8			
	r9			
	r10			
	r11			
	r12			
r13 (sp)	r13 (sp)	r13 (sp)	r13 (sp)	r13 (sp)
r14 (lr)	r14 (lr)	r14 (lr)	r14 (lr)	r14 (lr)
	spsr	spsr	spsr	spsr



Register Organization Summary

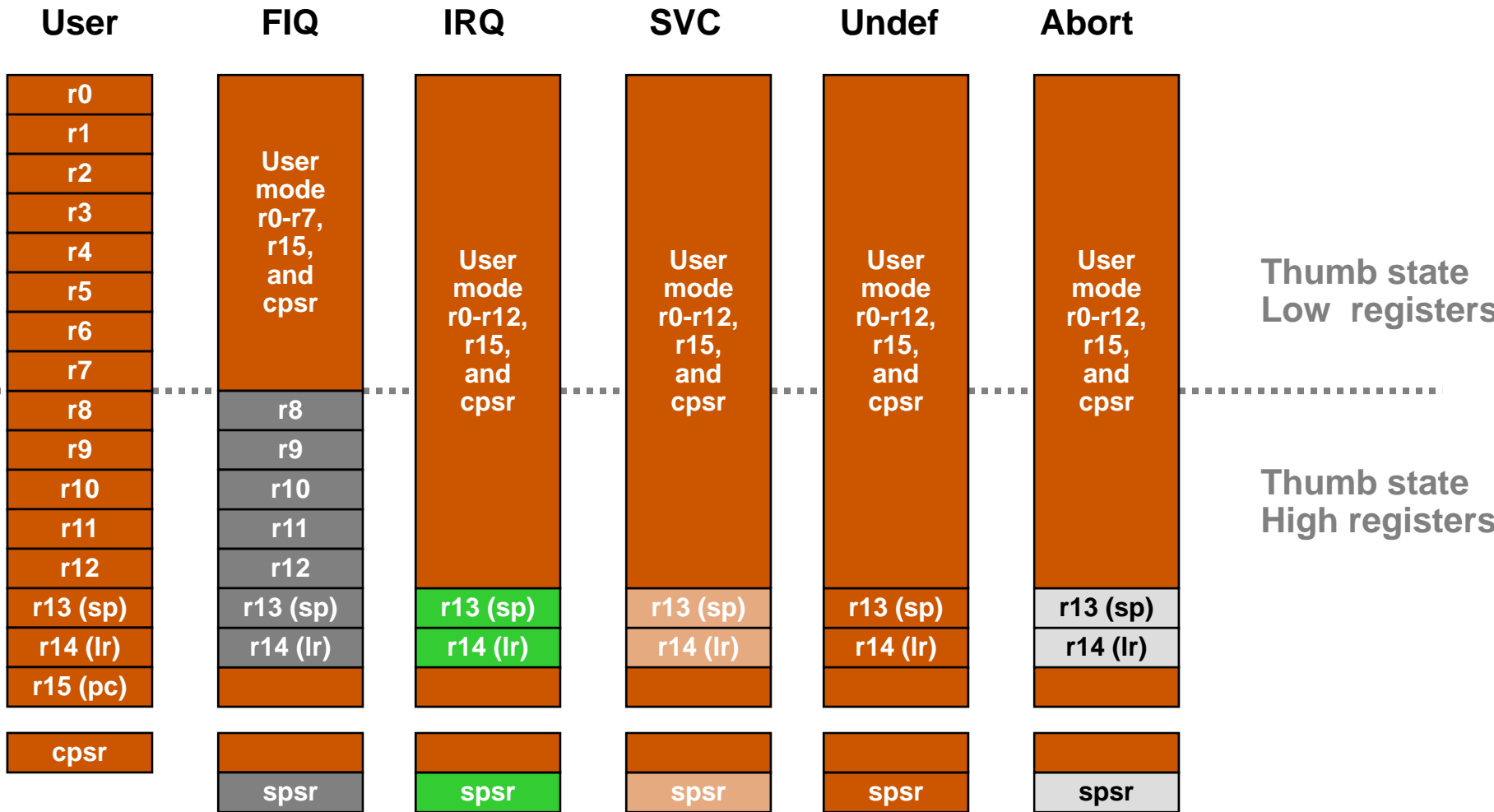

Note: System mode uses the User mode register set

Accessing Registers using ARM Instructions

- **No breakdown of currently accessible registers.**
 - All instructions can access r0-r14 directly.
 - Most instructions also allow use of the PC.

- **Specific instructions to allow access to CPSR and SPSR.**

- **Note : When in a privileged mode, it is also possible to load-store the (banked out) user mode registers to or from memory.**

Condition Flags

	Logical Instruction	Arithmetic Instruction
Flag		
Negative (N='1')	No meaning	Bit 31 of the result has been set Indicates a negative number in signed operations
Zero (Z='1')	Result is all zeroes	Result of operation was zero
Carry (C='1')	After Shift operation '1' was left in carry flag	Result was greater than 32 bits
oVerflow (V='1')	No meaning	Result was greater than 31 bits Indicates a possible corruption of the sign bit in signed numbers

The Program Counter (R15)

- **When the processor is executing in ARM state:**
 - All instructions are 32 bits in length
 - All instructions must be word aligned
 - Therefore the PC value is stored in bits [31:2] with bits [1:0] equal to zero (as instruction cannot be halfword or byte aligned).
- **R14 is used as the subroutine link register (LR) and stores the return address when Branch with Link operations are performed, calculated from the PC.**
- **Thus to return from a linked branch:**

```
MOV r15,r14
    or
MOV pc,lr
```

Exception Handling and the Vector Table

- **When an exception occurs, the core:**
 - Copies CPSR into SPSR_<mode>
 - Sets appropriate CPSR bits
 - If core implements ARM Architecture 4T and is currently in Thumb state, then
 - ARM state is entered.
 - Mode field bits
 - Interrupt disable flags if appropriate.
 - Maps in appropriate banked registers
 - Stores the “return address” in LR_<mode>
 - Sets PC to vector address
- **To return, exception handler needs to:**
 - Restore CPSR from SPSR_<mode>
 - Restore PC from LR_<mode>

0x00000000	Reset
0x00000004	Undefined Instruction
0x00000008	Software Interrupt
0x0000000C	Prefetch Abort
0x00000010	Data Abort
0x00000014	Reserved
0x00000018	IRQ
0x0000001C	FIQ

The Original Instruction Pipeline

- **The ARM uses a pipeline in order to increase the speed of the flow of instructions to the processor.**
 - Allows several operations to be undertaken simultaneously, rather than serially.

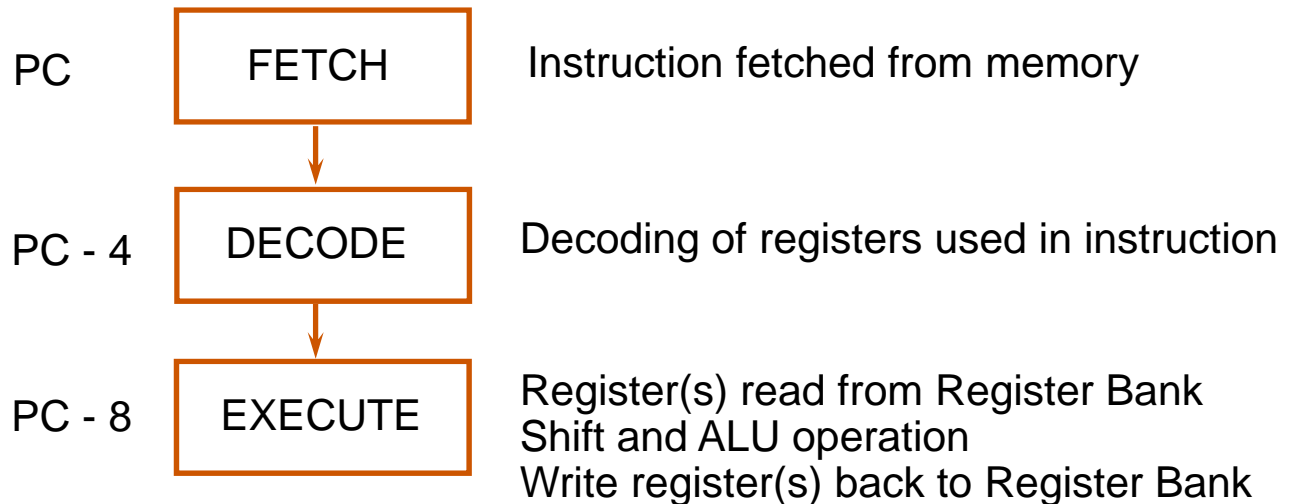

- **Rather than pointing to the instruction being executed, the PC points to the instruction being fetched.**

Pipeline changes for ARM9TDMI

ARM7TDMI

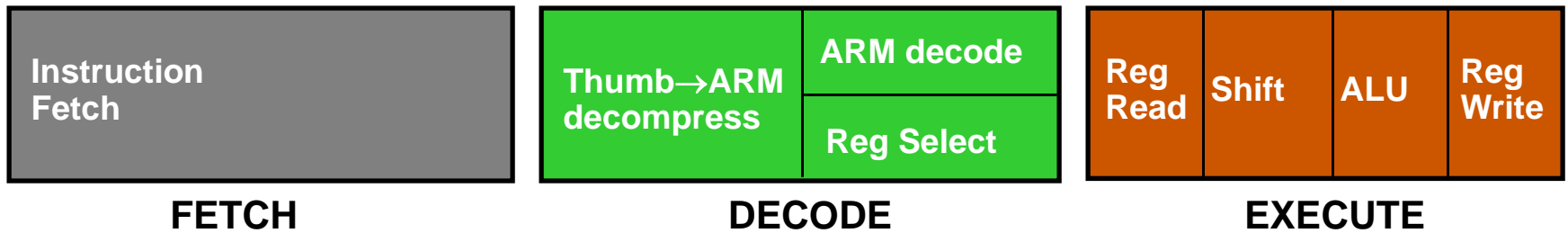

ARM9TDMI

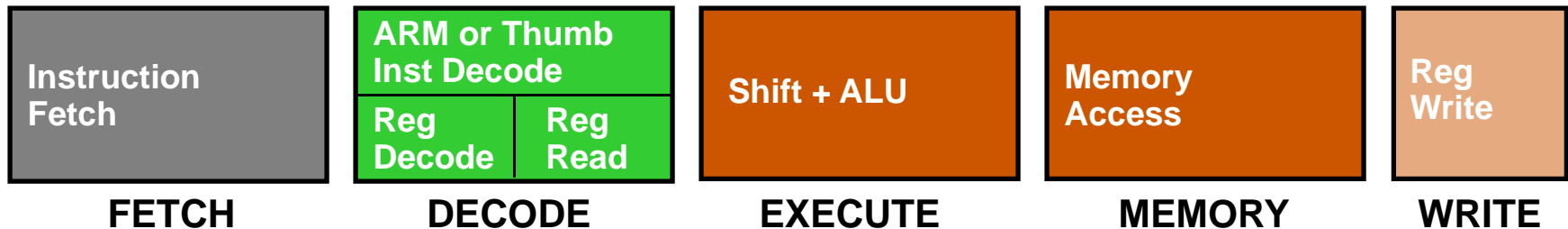

Pipeline changes for ARM10 vs. ARM11 Pipelines

ARM10

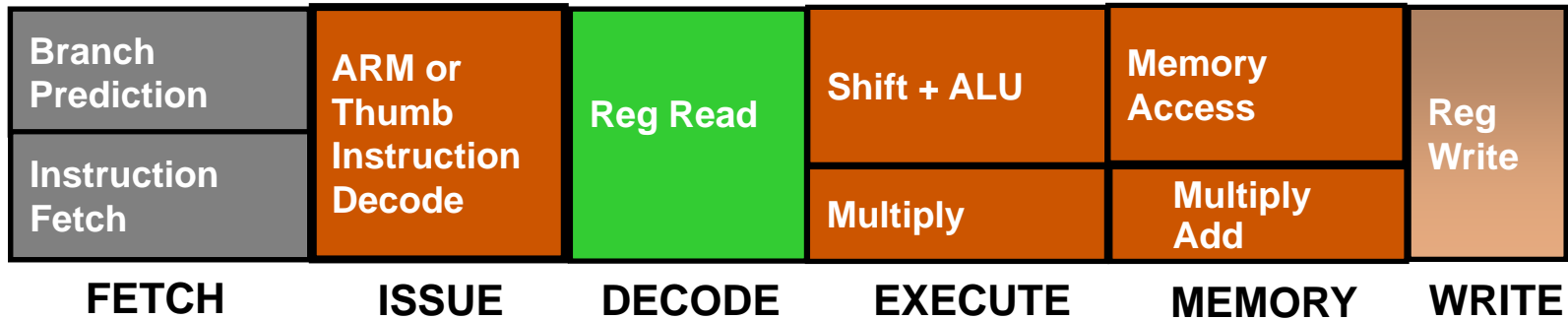

ARM11

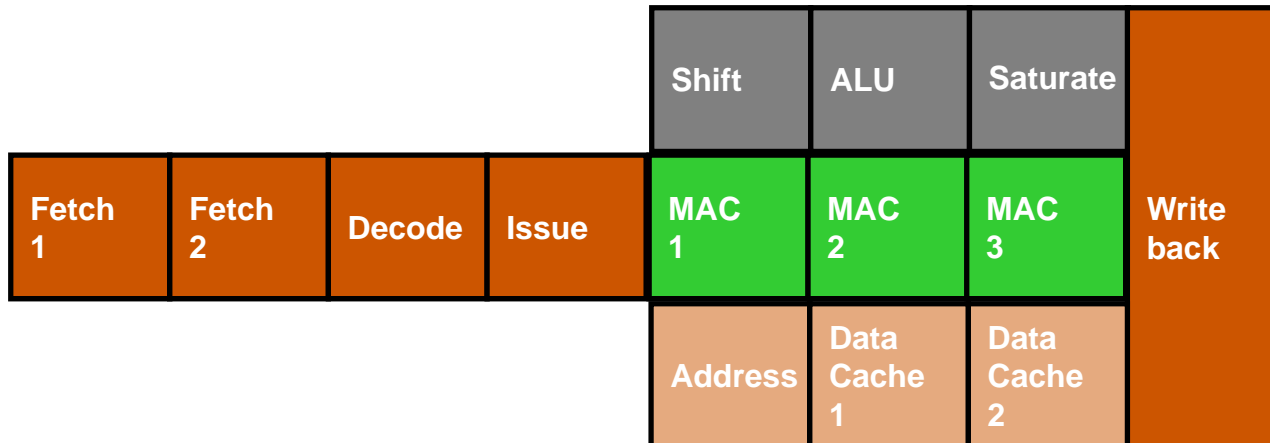

ARM Instruction Set Format

3 1	3 0	2 9	2 8	2 7	2 6	2 5	2 4	2 3	2 2	2 1	2 0	1 9	1 8	1 7	1 6	1 5	1 4	1 3	1 2	1 1	1 0	9	8	7	6	5	4	3	2	1	0	Instruction Type
Condition		0	0	I	OPCODE				S	Rn		Rs		OPERAND-2														Data processing				
Condition		0	0	0	0	0	0	A	S	Rd		Rn		Rs		1	0	0	1	Rm				Multiply								
Condition		0	0	0	0	1	U	A	S	Rd HIGH		Rd LOW		Rs		1	0	0	1	Rm				Long Multiply								
Condition		0	0	0	1	0	B	0	0	Rn		Rd		0	0	0	0	1	0	0	1	Rm				Swap						
Condition		0	1	I	P	U	B	W	L	Rn		Rd		OFFSET														Load/Store - Byte/Word				
Condition		1	0	0	P	U	B	W	L	Rn		REGISTER LIST																Load/Store Multiple				
Condition		0	0	0	P	U	1	W	L	Rn		Rd		OFFSET 1		1	S	H	1	OFFSET 2				Halfword Transfer Imm Off								
Condition		0	0	0	P	U	0	W	L	Rn		Rd		0	0	0	0	1	S	H	1	Rm				Halfword Transfer Reg Off						
Condition		1	0	1	L	BRANCH OFFSET																Branch										
Condition		0	0	0	1	0	0	1	0	1	1	1	1	1	1	1	1	1	1	1	1	1	0	0	0	1	Rn				Branch Exchange	
Condition		1	1	0	P	U	N	W	L	Rn		CRd		CPNum		OFFSET														COPROCESSOR DATA XFER		
Condition		1	1	1	0	Op-1				CRn		CRd		CPNum		OP-2		0	CRm				COPROCESSOR DATA OP									
Condition						OP-1		L	CRn		Rd		CPNum		OP-2		1	CRm				COPROCESSOR REG XFER										
Condition		1	1	1	1	SWI NUMBER																Software Interrupt										



Conditional Execution

- **Most instruction sets only allow branches to be executed conditionally.**
- **However by reusing the condition evaluation hardware, ARM effectively increases number of instructions.**
 - All instructions contain a condition field which determines whether the CPU will execute them.
 - Non-executed instructions consume 1 cycle.
 - Can't collapse the instruction like a NOP. Still have to complete cycle so as to allow fetching and decoding of the following instructions.
- **This removes the need for many branches, which stall the pipeline (3 cycles to refill).**
 - Allows very dense in-line code, without branches.
 - The Time penalty of not executing several conditional instructions is frequently less than overhead of the branch or subroutine call that would otherwise be needed.

The Condition Field

3	3	2	2	2	2	2	2	2	2	2	1	1	1	1	1	1	1	1	1	1	0	9	8	7	6	5	4	3	2	1	0	Instruction Type
1	0	9	8	7	6	5	4	3	2	1	0	9	8	7	6	5	4	3	2	1	0	9	8	7	6	5	4	3	2	1	0	
Condition				0	0	I	OPCODE				S	Rn			Rs			OPERAND-2										Data processing				

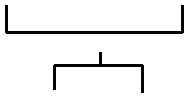

- 0000 = EQ - Z set (equal)
- 0001 = NE - Z clear (not equal)
- 0010 = HS / CS - C set (unsigned higher or same)
- 0011 = LO / CC - C clear (unsigned lower)
- 0100 = MI -N set (negative)
- 0101 = PL - N clear (positive or zero)
- 0110 = VS - V set (overflow)
- 0111 = VC - V clear (no overflow)
- 1000 = HI - C set and Z clear (unsigned higher)

- 1001 = LS - C clear or Z (set unsigned lower or same)
- 1010 = GE - N set and V set, or N clear and V clear (>or =)
- 1011 = LT - N set and V clear, or N clear and V set (>)
- 1100 = GT - Z clear, and either N set and V set, or N clear and V set (>)
- 1101 = LE - Z set, or N set and V clear, or N clear and V set (<, or =)
- 1110 = AL - always
- 1111 = NV - reserved.

Conditional Execution and Flags

- ARM instructions can be made to execute conditionally by postfixing them with the appropriate condition code field.
 - This improves code density *and* performance by reducing the number of forward branch instructions.

```

CMP    r3,#0
BEQ    skip
ADD    r0,r1,r2
skip
    
```

```

CMP    r3,#0
ADDNE  r0,r1,r2
    
```

- By default, data processing instructions do not affect the condition code flags but the flags can be optionally set by using “S”. CMP does not need “S”.

```

loop
...
SUBS  r1,r1,#1
BNE  loop
    
```

Branch instructions (2)

- **When executing the instruction, the processor:**
 - shifts the offset left two bits, sign extends it to 32 bits, and adds it to PC.
- **Execution then continues from the new PC, once the pipeline has been refilled.**
- **The "Branch with link" instruction implements a subroutine call by writing PC-4 into the LR of the current bank.**
 - i.e. the address of the next instruction following the branch with link (allowing for the pipeline).
- **To return from subroutine, simply need to restore the PC from the LR:**
 - MOV pc, lr
 - Again, pipeline has to refill before execution continues.

Branch instructions (3)

- The "Branch" instruction does not affect LR.
- **Note: Architecture 4T offers a further ARM branch instruction, BX**
 - See Thumb Instruction Set Module for details.
- **BL <subroutine>**
 - Stores return address in LR
 - Returning implemented by restoring the PC from LR
 - For non-leaf functions, LR will have to be stacked

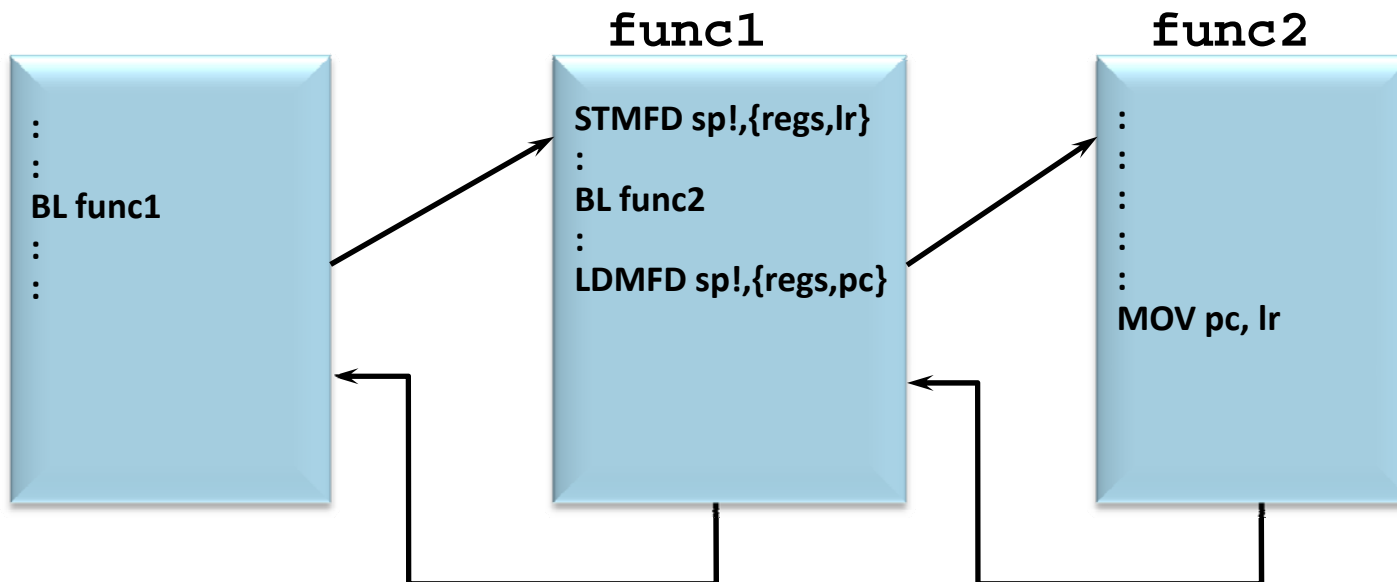

Conditional Branches

Branch	Interpretation	Normal uses
B	Unconditional	Always take this branch
BAL	Always	Always take this branch
BEQ	Equal	Comparison equal or zero result
BNE	Not equal	Comparison not equal or non-zero result
BPL	Plus	Result positive or zero
BMI	Minus	Result minus or negative
BCC	Carry clear	Arithmetic operation did not give carry-out
BLO	Lower	Unsigned comparison gave lower
BCS	Carry set	Arithmetic operation gave carry-out
BHS	Higher or same	Unsigned comparison gave higher or same
BVC	Overflow clear	Signed integer operation; no overflow occurred
BVS	Overflow set	Signed integer operation; overflow occurred
BGT	Greater than	Signed integer comparison gave greater than
BGE	Greater or equal	Signed integer comparison gave greater or equal
BLT	Less than	Signed integer comparison gave less than
BLE	Less or equal	Signed integer comparison gave less than or equal
BHI	Higher	Unsigned comparison gave higher
BLS	Lower or same	Unsigned comparison gave lower or same

Data processing Instructions

- **Largest family of ARM instructions, all sharing the same instruction format.**
- **Contains:**
 - Arithmetic operations
 - Comparisons (no results - just set condition codes)
 - Logical operations
 - Data movement between registers
- **Remember, this is a load / store architecture**
 - These instruction only work on registers, **NOT** memory.
- **They each perform a specific operation on one or two operands.**
 - First operand always a register - Rn
 - Second operand sent to the ALU via barrel shifter.
- **We will examine the barrel shifter shortly.**

Arithmetic Operations

Operations are:

- **ADD** operand1 + operand2 ; Add
- **ADC** operand1 + operand2 + carry ; Add with carry
- **SUB** operand1 - operand2 ; Subtract
- **SBC** operand1 - operand2 + carry -1 ; Subtract with carry
- **RSB** operand2 - operand1 ; Reverse subtract
- **RSC** operand2 - operand1 + carry - 1 ; Reverse subtract with carry

Syntax:

- <Operation>{<cond>}{S} Rd, Rn, Operand2

Examples

- **ADD** r0, r1, r2
- **SUBGT** r3, r3, #1
- **RSBLES** r4, r5, #5

Comparisons

- **The only effect of the comparisons is to update the condition flags. Thus no need to set S bit.**
- **Operations are:**
 - **CMP** operand1 - operand2 ; Compare
 - **CMN** operand1 + operand2 ; Compare negative
 - **TST** operand1 AND operand2 ; Test
 - **TEQ** operand1 EOR operand2 ; Test equivalence
- **Syntax:**
 - **<Operation>{<cond>} Rn, Operand2**
- **Examples:**
 - **CMP** r0, r1
 - **TSTEQ** r2, #5

Logical Operations

- **Operations are:**

AND operand1 AND operand2

EOR operand1 EOR operand2

ORR operand1 OR operand2

ORN operand1 NOR operand2

BIC operand1 AND NOT operand2 [ie bit clear]

- **Syntax:**

– <Operation>{<cond>}{S} Rd, Rn, Operand2

- **Examples:**

AND r0, r1, r2

BICEQ r2, r3, #7

EORS r1,r3,r0

Data Movement

- **Operations are:**

MOV operand2

MVN NOT operand2

Note that these make no use of operand1.

- **Syntax:**

— <Operation>{<cond>}{S} Rd, Operand2

- **Examples:**

MOV r0, r1

MOVS r2, #10

MVNEQ r1,#0

The Barrel Shifter

- **The ARM doesn't have actual shift instructions.**
- **Instead it has a barrel shifter which provides a mechanism to carry out shifts as part of other instructions.**
- **So what operations does the barrel shifter support?**

Barrel Shifter - Left Shift

- Shifts left by the specified amount (multiplies by powers of two)

e.g.

LSL #5 => multiply by 32

Logical Shift Left (LSL)



Barrel Shifter - Right Shifts

Logical Shift Right (LSR)

Shifts right by the specified amount (divides by powers of two) e.g.

LSR #5 = divide by 32

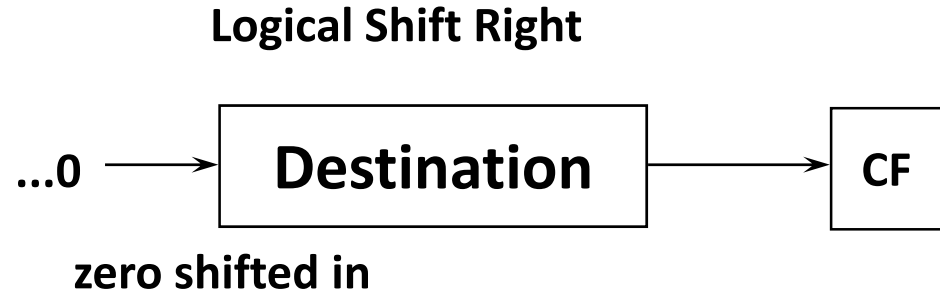

Arithmetic Shift Right (ASR)

Shifts right (divides by powers of two) and preserves the sign bit, for 2's complement operations. e.g.

ASR #5 = divide by 32



Barrel Shifter - Rotations

Rotate Right (ROR)

Similar to an ASR but the bits wrap around as they leave the LSB and appear as the MSB.

e.g. **ROR #5**

Note the last bit rotated is also used as the Carry Out.

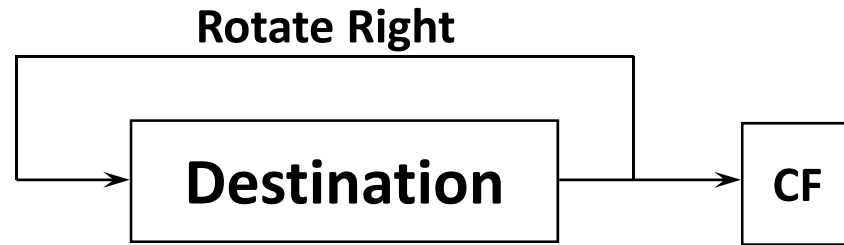

Rotate Right Extended (RRX)

This operation uses the CPSR C flag as a 33rd bit.

Rotates right by 1 bit. Encoded as **ROR #0**

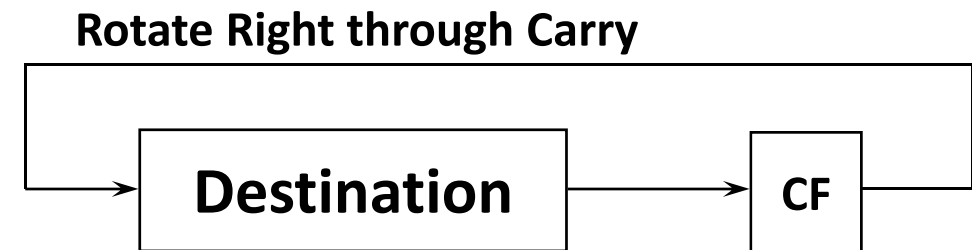

Using the Barrel Shifter: The Second Operand

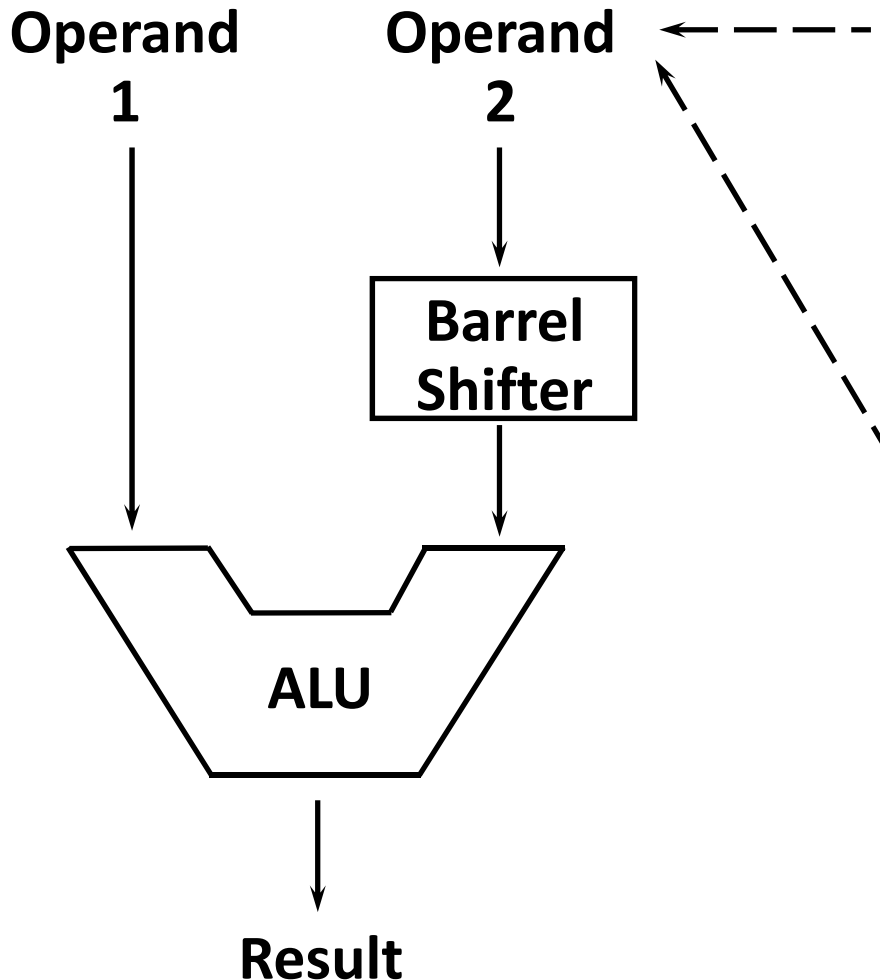

- Register, optionally with shift operation applied.
- Shift value can be either be:
 - 5 bit unsigned integer
 - Specified in bottom byte of another register.

- * Immediate value
 - 8 bit number
 - Can be rotated right through an even number of positions.
 - Assembler will calculate rotate for you from constant.

Second Operand : Shifted Register

- **The amount by which the register is to be shifted is contained in either:**
 - **the immediate 5-bit field in the instruction**
 - **NO OVERHEAD**
 - **Shift is done for free - executes in single cycle.**
 - **the bottom byte of a register (not PC)**
 - **Then takes extra cycle to execute**
 - **ARM doesn't have enough read ports to read 3 registers at once.**
 - **Then same as on other processors where shift is separate instruction.**

- **If no shift is specified then a default shift is applied: LSL #0**
 - **i.e. barrel shifter has no effect on value in register.**

Second Operand: Using a Shifted Register

- Using a multiplication instruction to multiply by a constant means first loading the constant into a register and then waiting a number of internal cycles for the instruction to complete.
- A more optimum solution can often be found by using some combination of MOVs, ADDs, SUBs and RSBs with shifts.
 - Multiplications by a constant equal to a $((\text{power of } 2) \pm 1)$ can be done in one cycle.

MOV R2, R0, LSL #2 ; Shift R0 left by 2, write to R2, (R2=R0x4)

ADD R9, R5, R5, LSL #3 ; R9 = R5 + R5 x 8 or R9 = R5 x 9

RSB R9, R5, R5, LSL #3 ; R9 = R5 x 8 - R5 or R9 = R5 x 7

SUB R10, R9, R8, LSR #4 ; R10 = R9 - R8 / 16

MOV R12, R4, ROR R3 ; R12 = R4 rotated right by value of R3

Second Operand: Immediate Value (1)

- **There is no single instruction which will load a 32 bit immediate constant into a register without performing a data load from memory.**
 - All ARM instructions are 32 bits long
 - ARM instructions do not use the instruction stream as data.
- **The data processing instruction format has 12 bits available for operand2**
 - If used directly this would only give a range of 4096.
- **Instead it is used to store 8 bit constants, giving a range of 0 - 255.**
- **These 8 bits can then be rotated right through an even number of positions (ie RORs by 0, 2, 4,..30).**
 - This gives a much larger range of constants that can be directly loaded, though some constants will still need to be loaded from memory.

Second Operand: Immediate Value (2)

- **This gives us:**
 - 0 - 255 [0 - 0xff]
 - 256,260,264,...,1020 [0x100-0x3fc, step 4, 0x40-0xff ror 30]
 - 1024,1040,1056,...,4080 [0x400-0xff0, step 16, 0x40-0xff ror 28]
 - 4096,4160, 4224,...,16320 [0x1000-0x3fc0, step 64, 0x40-0xff ror 26]
- **These can be loaded using, for example:**
 - MOV r0, #0x40, 26 ; => MOV r0, #0x1000 (ie 4096)
- **To make this easier, the assembler will convert to this form for us if simply given the required constant:**
 - MOV r0, #4096 ; => MOV r0, #0x1000 (ie 0x40 ror 26)
- **The bitwise complements can also be formed using MVN:**
 - MOV r0, #0xFFFFFFFF ; assembles to MVN r0, #0
- **If the required constant cannot be generated, an error will be reported.**

Loading full 32 bit constants

- Although the MOV/MVN mechanism will load a large range of constants into a register, sometimes this mechanism will not generate the required constant.
- Therefore, the assembler also provides a method which will load ANY 32 bit constant:
 - LDR rd,=numeric constant
- If the constant can be constructed using either a MOV or MVN then this will be the instruction actually generated.
- Otherwise, the assembler will produce an LDR instruction with a PC-relative address to read the constant from a literal pool.

```
LDR r0,=0x42           ; generates MOV r0,#0x42
LDR r0,=0x55555555    ; generate LDR r0,[pc, offset to lit pool]
                        :
                        :
                        DCD 0x55555555
```

- As this mechanism will always generate the best instruction for a given case, it is the recommended way of loading constants.

Multiplication Instructions

- **The Basic ARM provides two multiplication instructions.**
- **Multiply**
 - $MUL\{\langle cond \rangle\}\{S\} Rd, Rm, Rs$; $Rd = Rm * Rs$
- **Multiply Accumulate - does addition for free**
 - $MLA\{\langle cond \rangle\}\{S\} Rd, Rm, Rs, Rn$; $Rd = (Rm * Rs) + Rn$
- **Restrictions on use:**
 - **Rd and Rm cannot be the same register**
 - **Can be avoided by swapping Rm and Rs around. This works because multiplication is commutative.**
 - **Cannot use PC.**
- **These will be picked up by the assembler if overlooked.**
- **Operands can be considered signed or unsigned**
 - **Up to user to interpret correctly.**

Multiplication Implementation

- The ARM makes use of Booth's Algorithm to perform integer multiplication.
- On non-M ARMs this operates on 2 bits of Rs at a time.
 - For each pair of bits this takes 1 cycle (plus 1 cycle to start with).
 - However when there are no more 1's left in Rs, the multiplication will early-terminate.
- Example: Multiply 18 and -1 : $Rd = Rm * Rs$

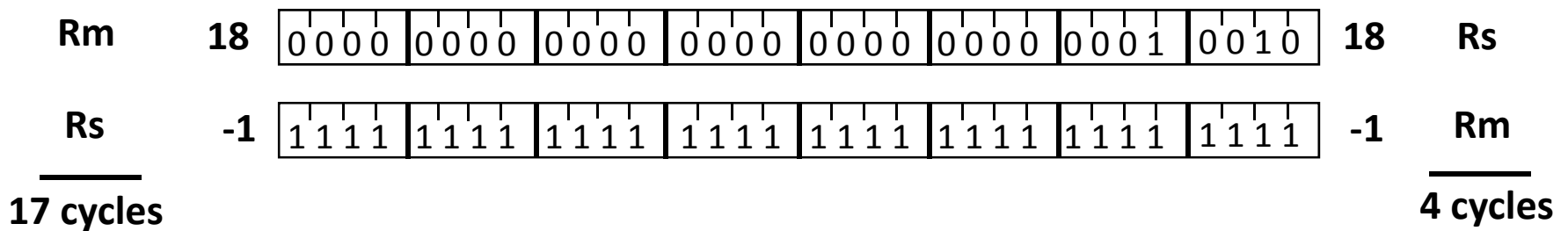

- Note: Compiler does not use early termination criteria to decide on which order to place operands.



Extended Multiply Instructions

- **M variants of ARM cores contain extended multiplication hardware. This provides three enhancements:**
 - **An 8 bit Booth's Algorithm is used**
 - Multiplication is carried out faster (maximum for standard instructions is now 5 cycles).
 - **Early termination method improved so that now completes multiplication when all remaining bit sets contain**
 - all zeroes (as with non-M ARMs), or
 - all ones.
 - **Thus the previous example would early terminate in 2 cycles in both cases.**
 - **64 bit results can now be produced from two 32bit operands**
 - Higher accuracy.
 - Pair of registers used to store result.

Multiply-Long & Multiply-Accumulate Long

- **Instructions are**
 - MULL which gives $RdHi, RdLo := Rm * Rs$
 - MLAL which gives $RdHi, RdLo := (Rm * Rs) + RdHi, RdLo$
- **However the full 64 bit of the result now matter (lower precision multiply instructions simply throws top 32bits away)**
 - Need to specify whether operands are signed or unsigned
- **Therefore syntax of new instructions are:**
 - UMULL{<cond>}{S} RdLo, RdHi, Rm, Rs
 - UMLAL{<cond>}{S} RdLo, RdHi, Rm, Rs
 - SMULL{<cond>}{S} RdLo, RdHi, Rm, Rs
 - SMLAL{<cond>}{S} RdLo, RdHi, Rm, Rs
- **Not generated by the compiler.**
- **Warning : Unpredictable on non-M ARM.**

Load / Store Instructions

- **The ARM is a Load / Store Architecture:**
 - Does not support memory to memory data processing operations.
 - Must move data values into registers before using them.
- **This might sound inefficient, but in practice it isn't:**
 - Load data values from memory into registers.
 - Process data in registers using a number of data processing instructions which are not slowed down by memory access.
 - Store results from registers out to memory.
- **The ARM has three sets of instructions which interact with main memory. These are:**
 - Single register data transfer (LDR / STR).
 - Block data transfer (LDM/STM).
 - Single Data Swap (SWP).

Single register data transfer

- **The basic load and store instructions are:**
 - Load and Store Word or Byte
 - LDR / STR / LDRB / STRB
- **ARM Architecture Version 4 also adds support for Halfwords and signed data.**
 - Load and Store Halfword
 - LDRH / STRH
 - Load Signed Byte or Halfword - load value and sign extend it to 32 bits.
 - LDRSB / LDRSH
- **All of these instructions can be conditionally executed by inserting the appropriate condition code after STR / LDR.**
 - e.g. LDREQB
- **Syntax:**
 - <LDR|STR>{<cond>}{<size>} Rd, <address>

Load and Store Word or Byte: Base Register

- The memory location to be accessed is held in a base register

STR r0, [r1] ; Store contents of r0 to location pointed to
 ; by contents of r1.

LDR r2, [r1] ; Load r2 with contents of memory location
 ; pointed to by contents of r1.

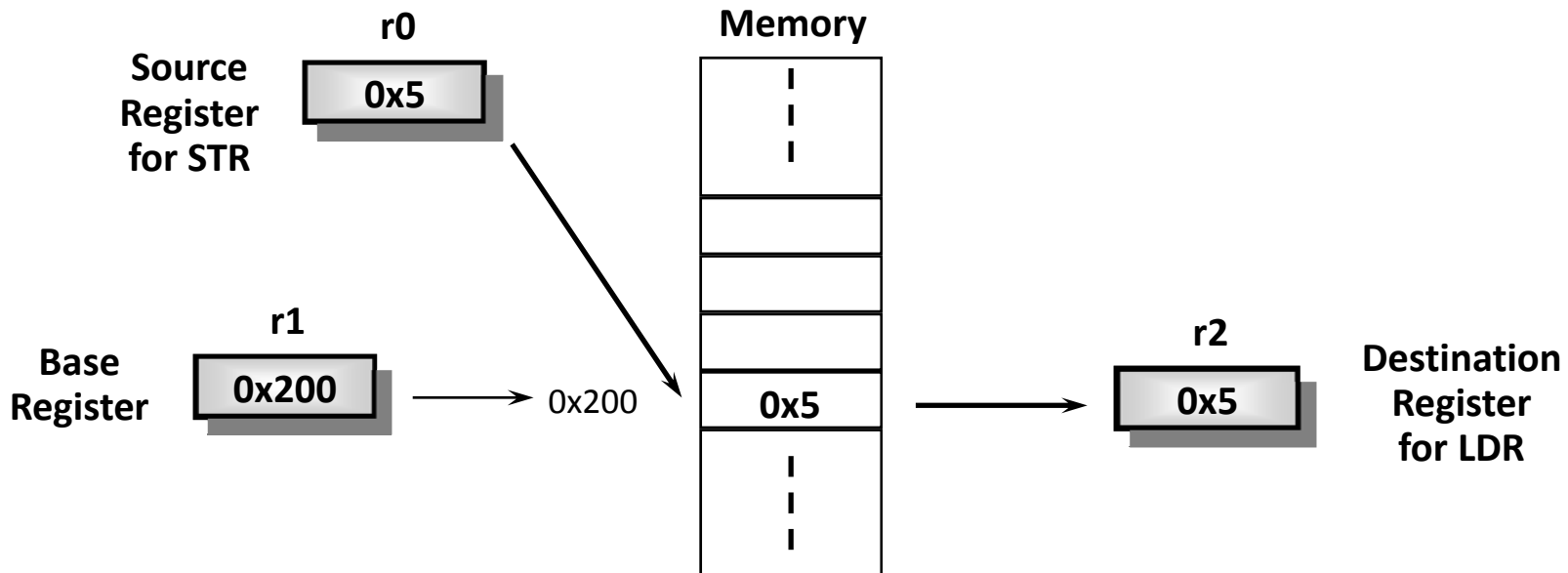

Load/Store Word or Byte: Offsets from the Base Register

- **As well as accessing the actual location contained in the base register, these instructions can access a location offset from the base register pointer.**
- **This offset can be**
 - An unsigned 12bit immediate value (ie 0 - 4095 bytes).
 - A register, optionally shifted by an immediate value
- **This can be either added or subtracted from the base register:**
 - Prefix the offset value or register with '+' (default) or '-'.
- **This offset can be applied:**
 - before the transfer is made: *Pre-indexed addressing*
 - optionally auto-incrementing the base register, by postfixing the instruction with an '!'.
 - after the transfer is made: *Post-indexed addressing*
 - causing the base register to be auto-incremented.

Load/Store Word or Byte: Pre-indexed Addressing

■ Example: STR r0, [r1,#12]

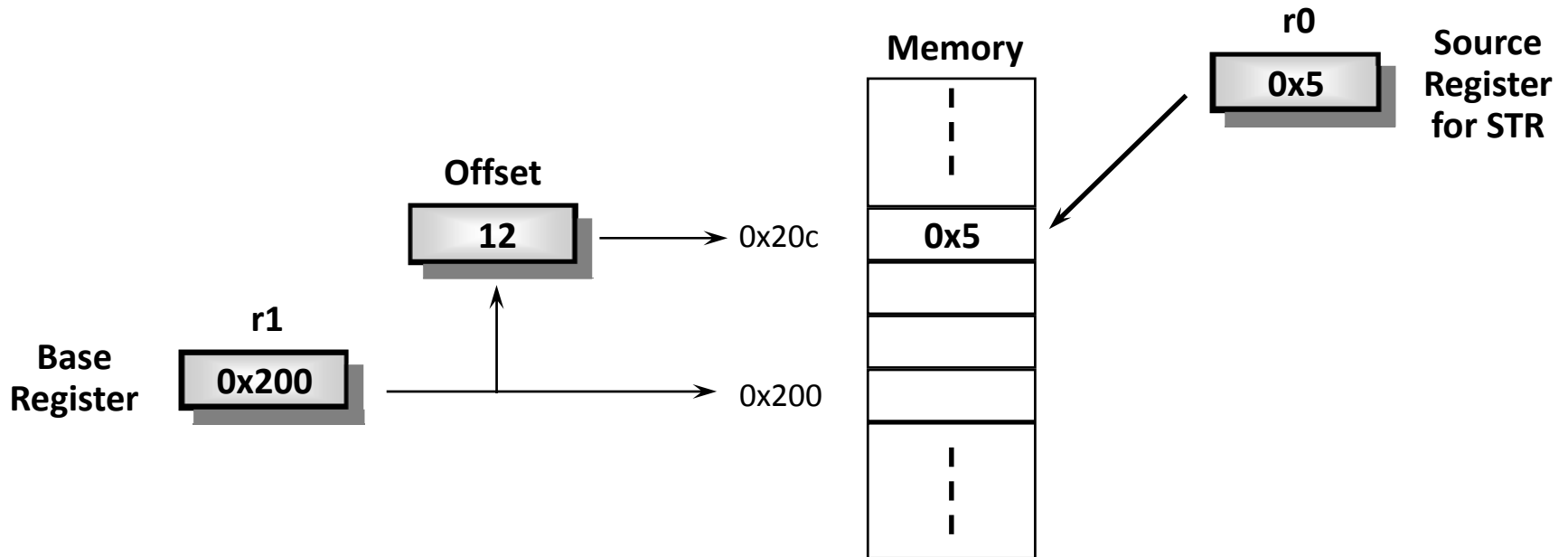

- To store to location 0x1f4 instead use: STR r0, [r1,#-12]
- To auto-increment base pointer to 0x20c use: STR r0, [r1, #12]!
- If r2 contains 3, access 0x20c by multiplying this by 4:
 - STR r0, [r1, r2, LSL #2]

Load and Store Word or Byte: Post-indexed Addressing

Example: `STR r0, [r1], #12`

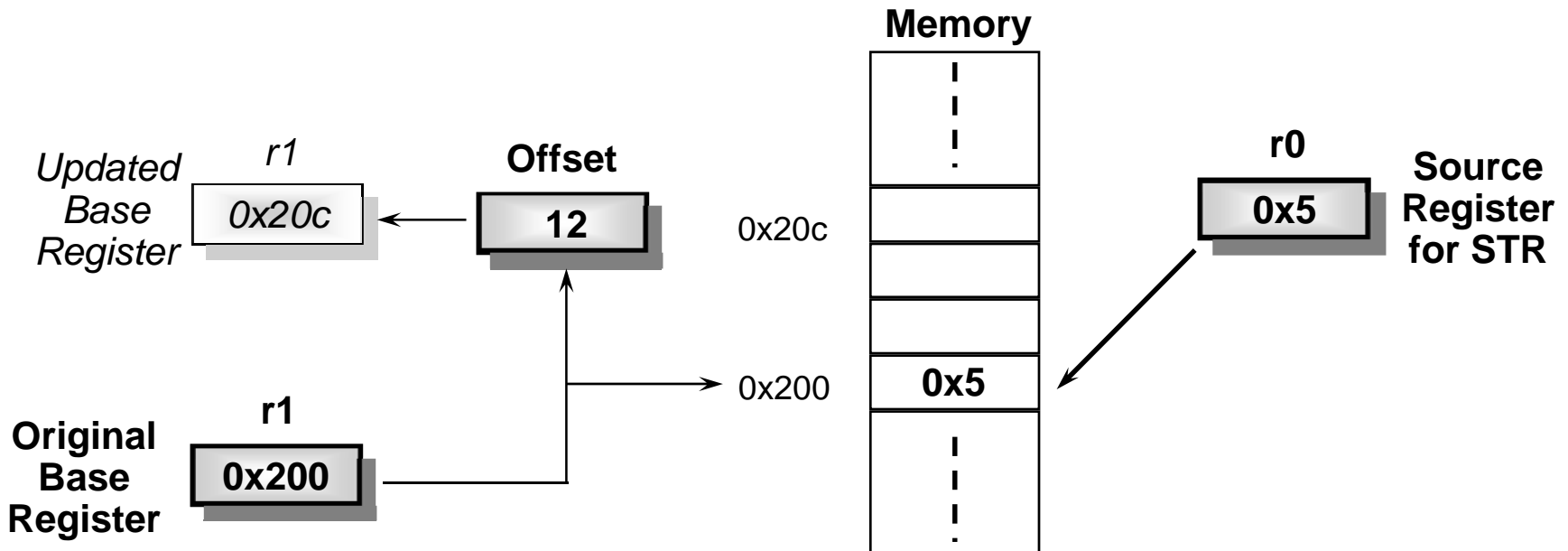

- To auto-increment the base register to location `0x1f4` instead use:
 - `STR r0, [r1], #-12`
- If `r2` contains 3, auto-increment base register to `0x20c` by multiplying this by 4:
 - `STR r0, [r1], r2, LSL #2`

Load and Stores with User Mode Privilege

- **When using post-indexed addressing, there is a further form of Load/Store Word/Byte:**
 - **<LDR|STR>{<cond>}{B}T Rd, <post_indexed_address>**

- **When used in a privileged mode, this does the load/store with user mode privilege.**
 - **Normally used by an exception handler that is emulating a memory access instruction that would normally execute in user mode.**

Example Usage of Addressing Modes

- Imagine an array, the first element of which is pointed to by the contents of r0.
- If we want to access a particular element, then we can use pre-indexed addressing:
 - r1 is element we want.
 - LDR r2, [r0, r1, LSL #2]
- If we want to step through every element of the array, for instance to produce sum of elements in the array, then we can use post-indexed addressing within a loop:
 - r1 is address of current element (initially equal to r0).
 - LDR r2, [r1], #4
- Use a further register to store the address of final element, so that the loop can be correctly terminated.

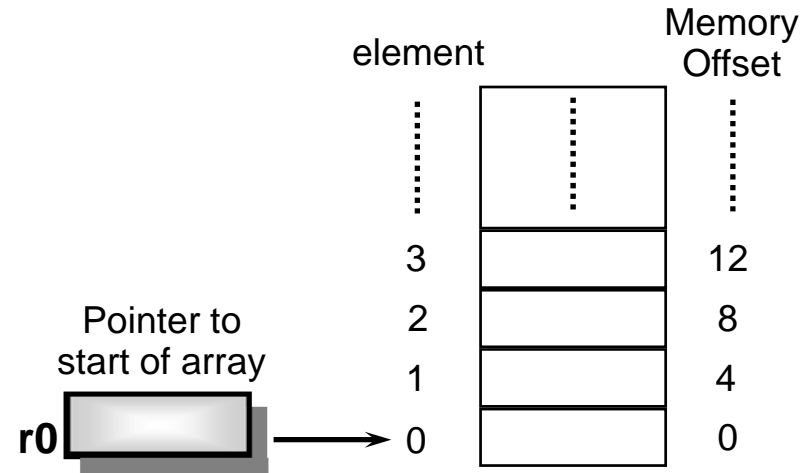

Offsets for Halfword and Signed Halfword / Byte Access

- **The Load and Store Halfword and Load Signed Byte or Halfword instructions can make use of pre- and post-indexed addressing in much the same way as the basic load and store instructions.**
- **However the actual offset formats are more constrained:**
 - The immediate value is limited to 8 bits (rather than 12 bits) giving an offset of 0-255 bytes.
 - The register form cannot have a shift applied to it.

Effect of endianness

- **The ARM can be set up to access its data in either little or big endian format.**
- **Little endian:**
 - Least significant byte of a word is stored in bits 0-7 of an addressed word.
- **Big endian:**
 - Least significant byte of a word is stored in bits 24-31 of an addressed word.
- **This has no real relevance unless data is stored as words and then accessed in smaller sized quantities (halfwords or bytes).**
 - Which byte / halfword is accessed will depend on the endianness of the system involved.

YA Endianness Example

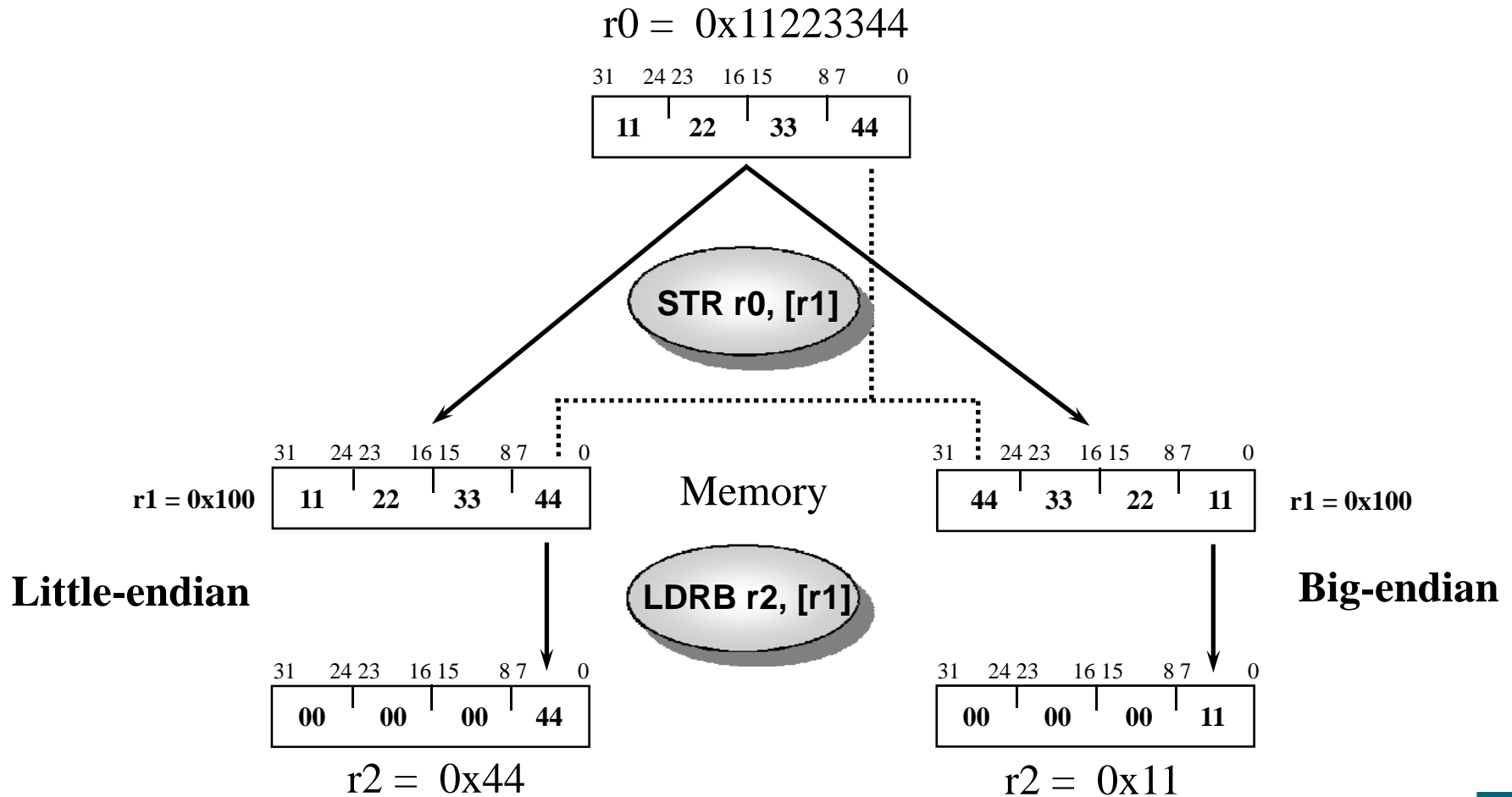

Block Data Transfer (1)

- The Load and Store Multiple instructions (LDM / STM) allow between 1 and 16 registers to be transferred to or from memory.
- The transferred registers can be either:
 - Any subset of the current bank of registers (default).
 - Any subset of the user mode bank of registers when in a privileged mode (postfix instruction with a '^').

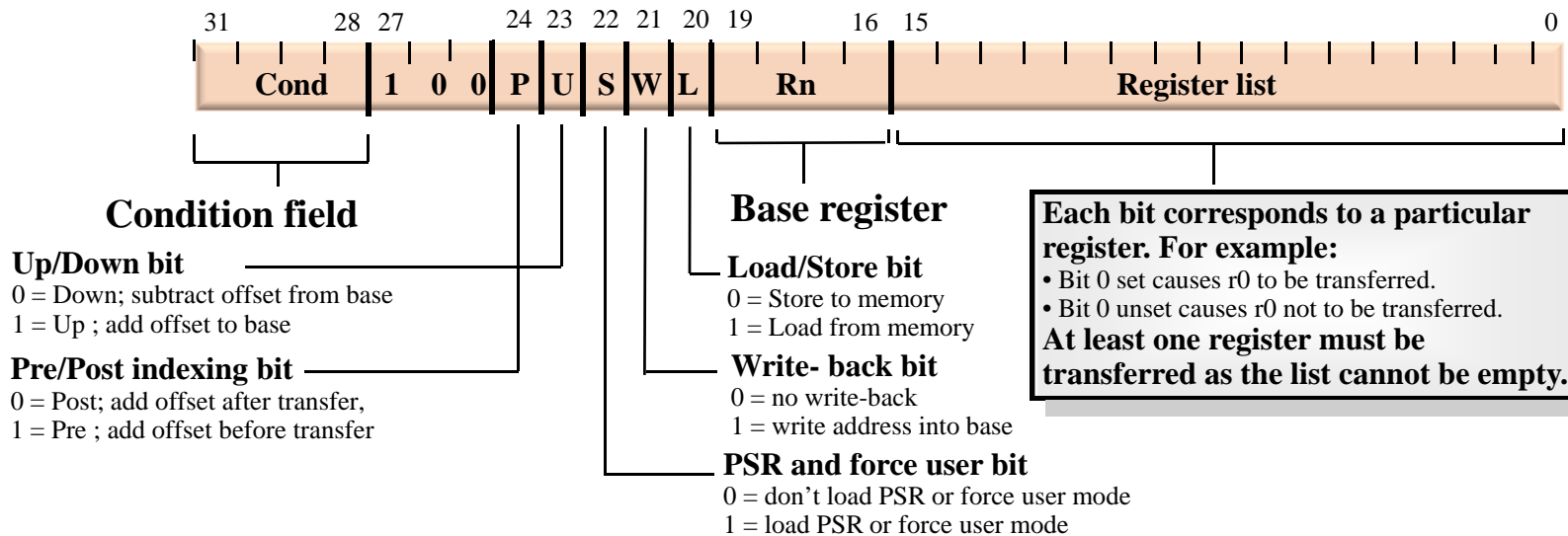

Block Data Transfer (2)

- **Base register used to determine where memory access should occur.**
 - 4 different addressing modes allow increment and decrement inclusive or exclusive of the base register location.
 - Base register can be optionally updated following the transfer (by appending it with an '!').
 - Lowest register number is always transferred to/from lowest memory location accessed.

- **These instructions are very efficient for**
 - Saving and restoring context
 - For this useful to view memory as a stack.
 - Moving large blocks of data around memory
 - For this useful to directly represent functionality of the instructions.

Stacks

- A stack is an area of memory which grows as new data is “pushed” onto the “top” of it, and shrinks as data is “popped” off the top.
- Two pointers define the current limits of the stack.
 - A base pointer
 - used to point to the “bottom” of the stack (the first location).
 - A stack pointer
 - used to point the current “top” of the stack.

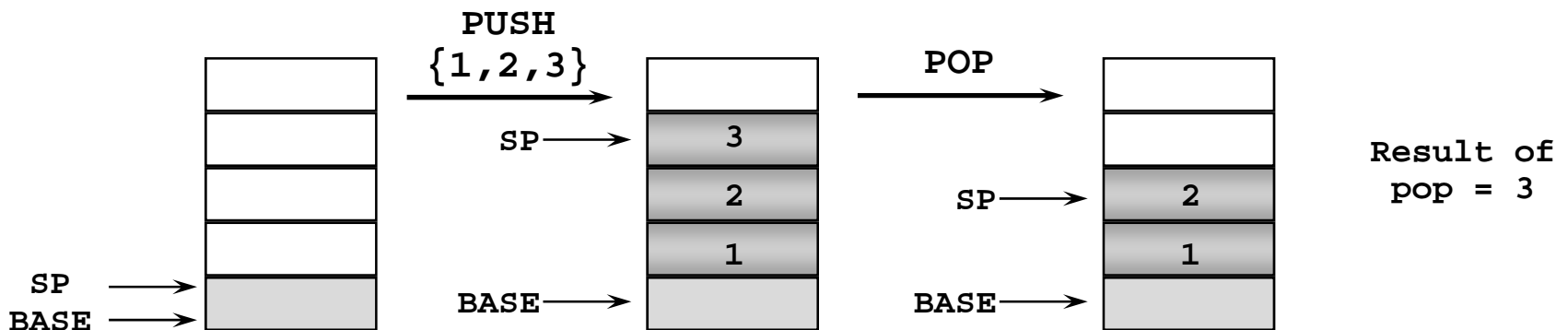

Stack Operation

- Traditionally, a stack grows down in memory, with the last “pushed” value at the lowest address. The ARM also supports ascending stacks, where the stack structure grows up through memory.
- The value of the stack pointer can either:
 - Point to the last occupied address (Full stack)
 - and so needs pre-decrementing (ie before the push)
 - Point to the next occupied address (Empty stack)
 - and so needs post-decrementing (ie after the push)
- The stack type to be used is given by the postfix to the instruction:
 - STMFD / LDMFD : Full Descending stack
 - STMFA / LDMFA : Full Ascending stack.
 - STMED / LDMED : Empty Descending stack
 - STMEA / LDMEA : Empty Ascending stack
- Note: ARM Compiler will always use a Full descending stack.

Stack Examples

STMFD sp!,
{r0,r1,r3-r5}

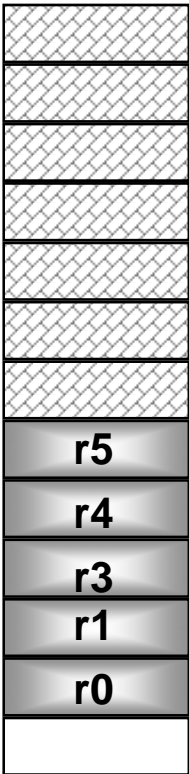

Old SP →

STMED sp!,
{r0,r1,r3-r5}

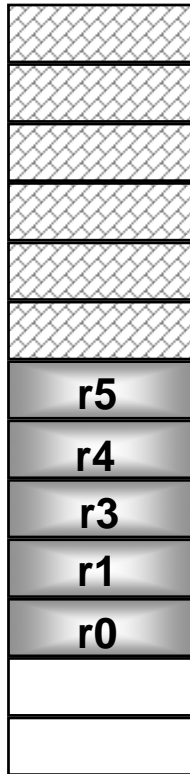

Old SP →

STMFA sp!,
{r0,r1,r3-r5}

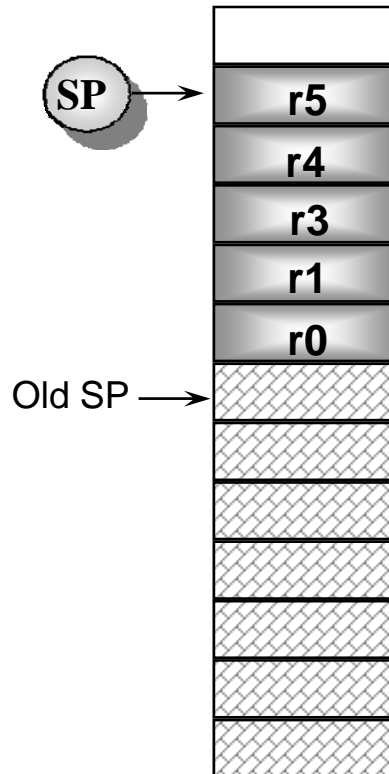

Old SP →

STMEA sp!,
{r0,r1,r3-r5}

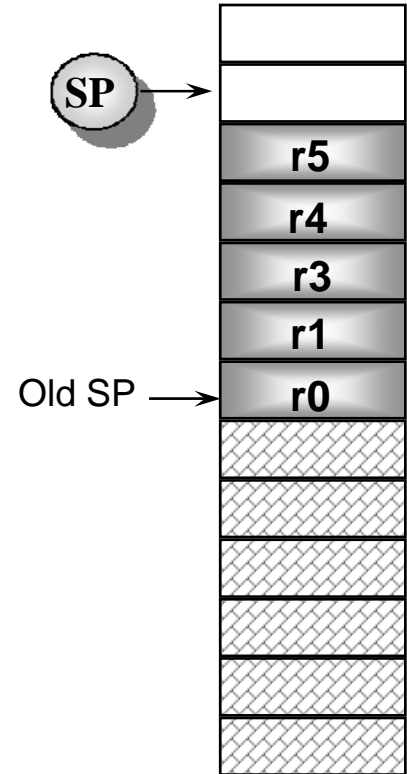

Old SP →

0x418

0x400

0x3e8

Stacks and Subroutines

- One use of stacks is to create temporary register workspace for subroutines. Any registers that are needed can be pushed onto the stack at the start of the subroutine and popped off again at the end so as to restore them before return to the caller :

```

STMFD sp!,{r0-r12, lr}           ; stack all registers
.....                           ; and the return address
.....
LDMFD sp!,{r0-r12, pc}          ; load all the registers
                                ; and return automatically
    
```

- See the chapter on the ARM Procedure Call Standard in the SDT Reference Manual for further details of register usage within subroutines.
- If the pop instruction also had the 'S' bit set (using '^') then the transfer of the PC when in a privileged mode would also cause the SPSR to be copied into the CPSR (see exception handling module).



Direct functionality of Block Data Transfer

- **When LDM / STM are not being used to implement stacks, it is clearer to specify exactly what functionality of the instruction is:**
 - i.e. specify whether to increment / decrement the base pointer, before or after the memory access.
- **In order to do this, LDM / STM support a further syntax in addition to the stack one:**
 - STMIA / LDMIA : Increment After
 - STMIB / LDMIB : Increment Before
 - STMDA / LDMDA : Decrement After
 - STMDB / LDMDB : Decrement Before

Example: Block Copy

- Copy a block of memory, which is an exact multiple of 12 words long from the location pointed to by r12 to the location pointed to by r13. r14 points to the end of block to be copied.

```

; r12 points to the start of the source data
; r14 points to the end of the source data
; r13 points to the start of the destination data
loop    LDMIA    r12!, {r0-r11} ; load 48 bytes
        STMIA    r13!, {r0-r11} ; and store them
        CMP     r12, r14        ; check for the end
        BNE     loop           ; and loop until done
    
```

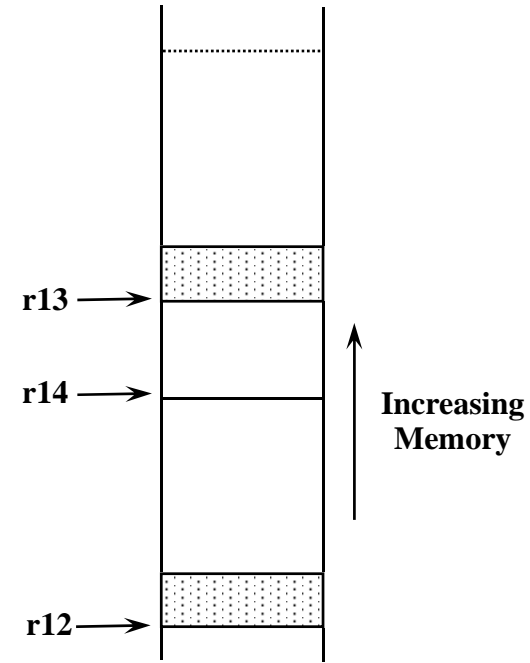

- This loop transfers 48 bytes in 31 cycles
- Over 50 Mbytes/sec at 33 MHz

Swap and Swap Byte Instructions

- Atomic operation of a memory read followed by a memory write which moves byte or word quantities between registers and memory.
- **Syntax:**
 - `SWP{<cond>}{B} Rd, Rm, [Rn]`

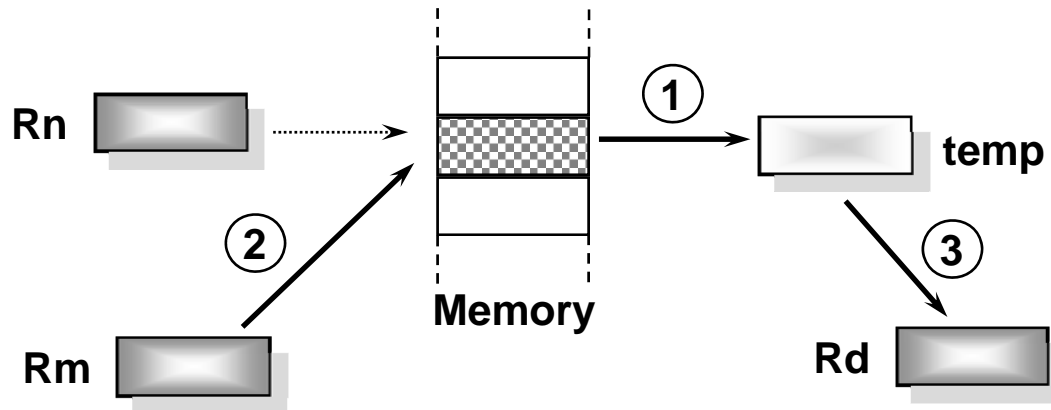

- To implement an actual swap of contents make $Rd = Rm$.
- The compiler cannot produce this instruction.

Backup

Assembler: Pseudo-ops

AREA -> chunks of data (\$data) or code (\$code)

ADR -> load address into a register

ADR R0, BUFFER

ALIGN -> adjust location counter to word boundary usually after a storage directive

END -> no more to assemble

Assembler: Pseudo-ops

DCD -> defined word value storage area
BOW DCD 1024, 2055, 9051

DCB -> defined byte value storage area
BOB DCB 10, 12, 15

% -> zeroed out byte storage area
BLBYTE % 30

Assembler: Pseudo-ops

IMPORT -> name of routine to import for use in this routine

IMPORT _printf ; C print routine

EXPORT -> name of routine to export for use in other routines

EXPORT add2 ; add2 routine

EQU -> symbol replacement

loopcnt EQU 5

Assembly Line Format

label <whitespace> *instruction* <whitespace> ; *comment*

label: created by programmer, alphanumeric

whitespace: space(s) or tab character(s)

instruction: op-code mnemonic or pseudo-op with required fields

comment: preceded by ; ignored by assembler but useful
 to the programmer for documentation

NOTE: All fields are optional.

Example: C assignments

- **C:**
`x = (a + b) - c;`
- **Assembler:**

```

ADR r4,a           ; get address for a
LDR r0,[r4]        ; get value of a
ADR r4,b           ; get address for b, reusing r4
LDR r1,[r4]        ; get value of b
ADD r3,r0,r1       ; compute a+b
ADR r4,c           ; get address for c
LDR r2,[r4]        ; get value of c
SUB r3,r3,r2       ; complete computation of x
ADR r4,x           ; get address for x
STR r3,[r4]        ; store value of x
        
```

Example: C assignment

- **C:**

```
y = a*(b+c);
```

- **Assembler:**

```
ADR r4,b ; get address for b
LDR r0,[r4] ; get value of b
ADR r4,c ; get address for c
LDR r1,[r4] ; get value of c
ADD r2,r0,r1 ; compute partial result
ADR r4,a ; get address for a
LDR r0,[r4] ; get value of a
MUL r2,r2,r0 ; compute final value for y
ADR r4,y ; get address for y
STR r2,[r4] ; store y
```

Example: C assignment

- **C:**

```
z = (a << 2) | (b & 15);
```

- **Assembler:**

```
ADR r4,a ; get address for a
LDR r0,[r4] ; get value of a
MOV r0,r0,LSL 2 ; perform shift
ADR r4,b ; get address for b
LDR r1,[r4] ; get value of b
AND r1,r1,#15 ; perform AND
ORR r1,r0,r1 ; perform OR
ADR r4,z ; get address for z
STR r1,[r4] ; store value for z
```

Example: if statement

- **C:**
`if (a > b) { x = 5; y = c + d; } else x = c - d;`

- **Assembler:**

`; compute and test condition`

`ADR r4,a ; get address for a`

`LDR r0,[r4] ; get value of a`

`ADR r4,b ; get address for b`

`LDR r1,[r4] ; get value for b`

`CMP r0,r1 ; compare a < b`

`BLE fblock ; if a >= b, branch to false block`

if statement, cont'd.

; true block

```
MOV r0,#5 ; generate value for x
ADR r4,x ; get address for x
STR r0,[r4] ; store x
ADR r4,c ; get address for c
LDR r0,[r4] ; get value of c
ADR r4,d ; get address for d
LDR r1,[r4] ; get value of d
ADD r0,r0,r1 ; compute y
ADR r4,y ; get address for y
STR r0,[r4] ; store y
B after ; branch around false block
```

if statement, cont'd.

; false block

`fblock ADR r4,c ; get address for c`

`LDR r0,[r4] ; get value of c`

`ADR r4,d ; get address for d`

`LDR r1,[r4] ; get value for d`

`SUB r0,r0,r1 ; compute a-b`

`ADR r4,x ; get address for x`

`STR r0,[r4] ; store value of x`

after ...

Example: Conditional instruction implementation

; true block

MOVLT r0,#5 ; generate value for x

ADRLT r4,x ; get address for x

STRLT r0,[r4] ; store x

ADRLT r4,c ; get address for c

LDRLT r0,[r4] ; get value of c

ADRLT r4,d ; get address for d

LDRLT r1,[r4] ; get value of d

ADDLT r0,r0,r1 ; compute y

ADRLT r4,y ; get address for y

STRLT r0,[r4] ; store y

Conditional instruction implementation, cont'd.

; false block

ADRGE r4,c ; get address for c

LDRGE r0,[r4] ; get value of c

ADRGE r4,d ; get address for d

LDRGE r1,[r4] ; get value for d

SUBGE r0,r0,r1 ; compute a-b

ADRGE r4,x ; get address for x

STRGE r0,[r4] ; store value of x

Example: switch statement

- **C:**
`switch (test) { case 0: ... break; case 1: ... }`
- **Assembler:**
`ADR r2,test ; get address for test`
`LDR r0,[r2] ; load value for test`
`ADR r1,switchtab ; load address for switch table`
`LDR r1,[r1,r0,LSL #2] ; index switch table`
`switchtab DCD case0`
`DCD case1`
`...`

Example: FIR filter

- **C:**

```
for (i=0, f=0; i<N; i++)
    f = f + c[i]*x[i];
```

- **Assembler**

; loop initiation code

```
MOV r0,#0 ; use r0 for I
```

```
MOV r8,#0 ; use separate index for arrays
```

```
ADR r2,N ; get address for N
```

```
LDR r1,[r2] ; get value of N
```

```
MOV r2,#0 ; use r2 for f
```

FIR filter, cont'.d

```

ADR r3,c ; load r3 with base of c
ADR r5,x ; load r5 with base of x
; loop body
loop LDR r4,[r3,r8] ; get c[i]
    LDR r6,[r5,r8] ; get x[i]
    MUL r4,r4,r6 ; compute c[i]*x[i]
    ADD r2,r2,r4 ; add into running sum
    ADD r8,r8,#4 ; add one word offset to array index
    ADD r0,r0,#1 ; add 1 to i
    CMP r0,r1 ; exit?
    BLT loop ; if i < N, continue
    
```

ARM Instruction Set Summary (1/4)

Mnemonic	Instruction	Action
ADC	Add with carry	$Rd := Rn + Op2 + Carry$
ADD	Add	$Rd := Rn + Op2$
AND	AND	$Rd := Rn \text{ AND } Op2$
B	Branch	$R15 := \text{address}$
BIC	Bit Clear	$Rd := Rn \text{ AND NOT } Op2$
BL	Branch with Link	$R14 := R15$ $R15 := \text{address}$
BX	Branch and Exchange	$R15 := Rn$ $T \text{ bit} := Rn[0]$
CDP	Coprocessor Data Processing	(Coprocessor-specific)
CMN	Compare Negative	$CPSR \text{ flags} := Rn + Op2$
CMP	Compare	$CPSR \text{ flags} := Rn - Op2$

ARM Instruction Set Summary (2/4)

Mnemonic	Instruction	Action
EOR	Exclusive OR	$Rd := Rn \wedge Op2$
LDC	Load Coprocessor from memory	(Coprocessor load)
LDM	Load multiple registers	Stack Manipulation (Pop)
LDR	Load register from memory	$Rd := (address)$
MCR	Move CPU register to coprocessor register	$CRn := rRn \{<op> cRm\}$
MLA	Multiply Accumulate	$Rd := (Rm * Rs) + Rn$
MOV	Move register or constant	$Rd := Op2$
MRC	Move from coprocessor register to CPU register	$rRn := cRn \{<op> cRm\}$
MRS	Move PSR status/flags to register	$Rn := PSR$
MSR	Move register to PSR status/flags	$PSR := Rm$

ARM Instruction Set Summary (3/4)

Mnemonic	Instruction	Action
MUL	Multiply	$Rd := Rm * Rs$
MVN	Move negative register	$Rd := \sim Op2$
ORR	OR	$Rd := Rn \text{ OR } Op2$
RSB	Reverse Subtract	$Rd := Op2 - Rn$
RSC	Reverse Subtract with Carry	$Rd := Op2 - Rn - 1 + \text{Carry}$
SBC	Subtract with Carry	$Rd := Rn - Op2 - 1 + \text{Carry}$
STC	Store coprocessor register to memory	$\text{address} := cRn$
STM	Store Multiple	Stack manipulation (Push)

ARM Instruction Set Summary (4/4)

Mnemonic	Instruction	Action
STR	Store register to memory	<address>:=Rd
SUB	Subtract	Rd:=Rn-Op2
SWI	Software Interrupt	OS call
SWP	Swap register with memory	Rd:=[Rn] [Rn]:=Rm
TEQ	Test bitwise equality	CPSR flags:=Rn EOR Op2
TST	Test bits	CPSR flags:=Rn AND Op2