

**Overview**

SEPIC converters make it possible to efficiently convert a DC voltage to either a lower or higher voltage. SEPIC converters are especially useful for PV maximum power tracking purposes, where the objective is to draw maximum possible power from solar panels at all times, regardless of the load.

**Theory of Operation**

*Relation Between  $V_{out}$  and  $V_{in}$  in Continuous Conduction*

The idealized SEPIC converter circuit is shown below in Figure 1. Under normal operation, the circuit is in “continuous conduction” (i.e.,  $i_{L1}$  and  $i_{L2}$  are always greater than zero).

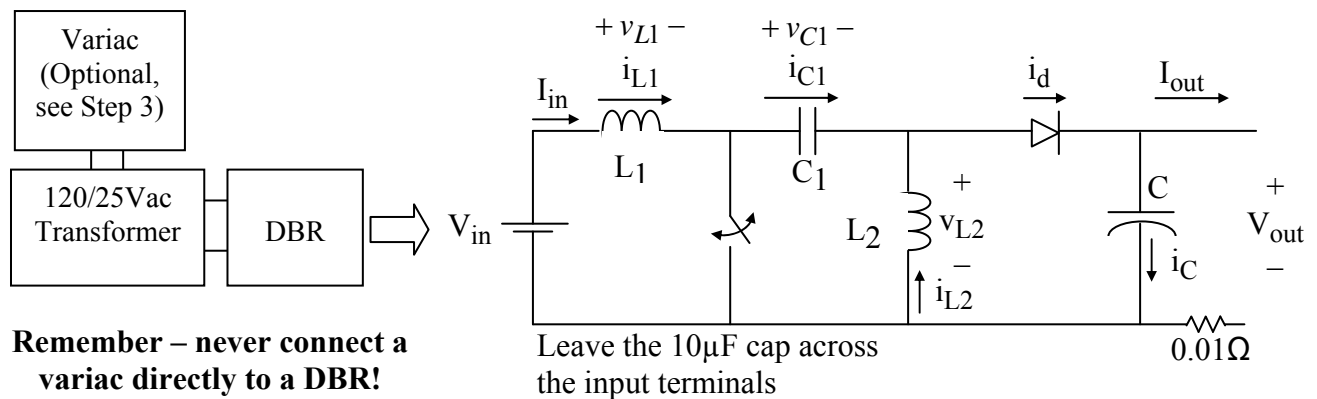

**Remember – never connect a variac directly to a DBR!**

Figure 1. DC-DC SEPIC Converter

The first important relationship comes from the fact that capacitor  $C_1$  should be large enough so that voltage  $v_{C1}$  has low ripple. Applying average KVL around the loop formed by  $V_{in}$ ,  $L_1$ ,  $C_1$ , and  $L_2$ , and recognizing that the average voltages across  $L_1$  and  $L_2$  are each zero, yields

$$v_{C1} = V_{in} \cdot \tag{1}$$

The second important relationship comes by applying KCL in the average sense at the node atop  $L_2$ . Since the average currents in  $C_1$  and  $C$  are both zero, then

$$i_{L2avg} = i_{davg} = I_{out} \cdot \tag{2}$$

With continuous conduction, the circuit has two states – switch closed, and switch open. These states are shown in Figures 2a and 2b.

## EE462L, Power Electronics, DC-DC SEPIC Converter

Version March 1, 2013

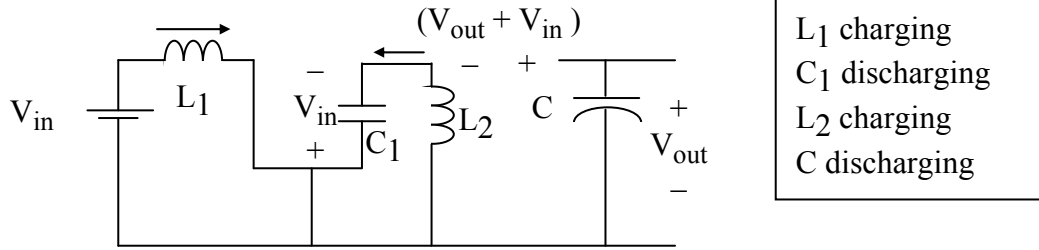

Figure 2a. Switch Closed for  $DT$  Seconds

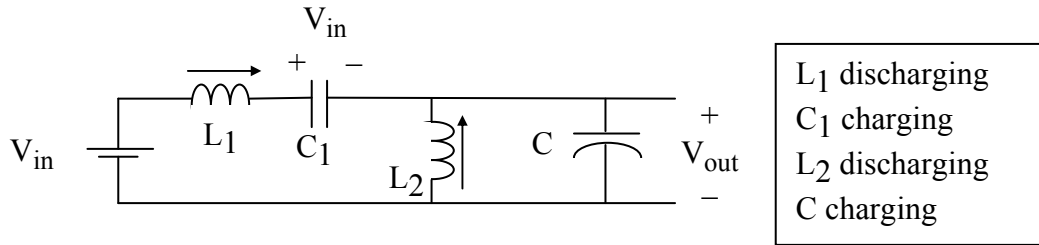

Figure 2b. Switch Open for  $(1-D)T$  Seconds

When the switch is closed (Figure 2a), the diode is reverse biased and open, current  $i_{L1}$  increases at the rate of

$$\frac{di_{L1}}{dt} = \frac{V_{in}}{L_1}, \quad 0 \leq t \leq DT, \quad (3)$$

so that  $L_1$  is “charging.” When the switch is open (Figure 2b), the diode is forward biased, and  $i_L$  decreases at the rate of

$$\frac{di_{L1}}{dt} = \frac{-V_{out}}{L_1}, \quad DT < t < T, \quad (4)$$

so that  $L_1$  is “discharging.” The voltage across  $L_1$  is shown in Figure 3.

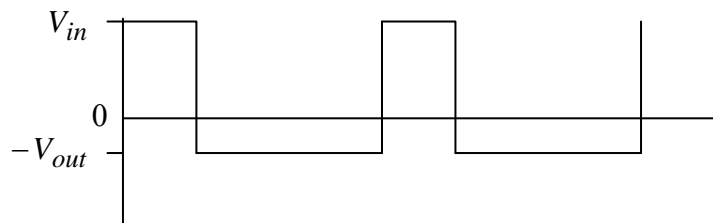

Figure 3. Inductor  $L_1$  Voltage in Continuous Conduction

Because of the steady-state inductor principle, the average voltage across  $L_1$  is zero. Since  $v_{L1}$  has two states, both having constant voltage, the average value of  $v_{L1}$  is

$$\frac{(V_{in})DT + (-V_{out})(1-D)T}{T} = 0,$$

so that

$$V_{in}D - V_{out} + V_{out}D = 0. \tag{5}$$

Simplifying the above yields the final input-output voltage expression

$$V_{out} = \frac{DV_{in}}{1-D}. \tag{6}$$

Thus, the converter is in “buck” mode for  $D < 0.5$ , and in “boost” mode for  $D > 0.5$ .

The assumption of a lossless circuit requires input power to equal output power, so

$$I_{out} = \frac{(1-D)I_{in}}{D}. \tag{7}$$

### ***Inductor Currents in Continuous Conduction***

The graph of  $i_{L1}$  is shown in Figure 4. For PV applications, it is obviously desirable to have low ripple in  $i_{L1}$  to keep the solar panel operating at the peak of its maximum power curve.

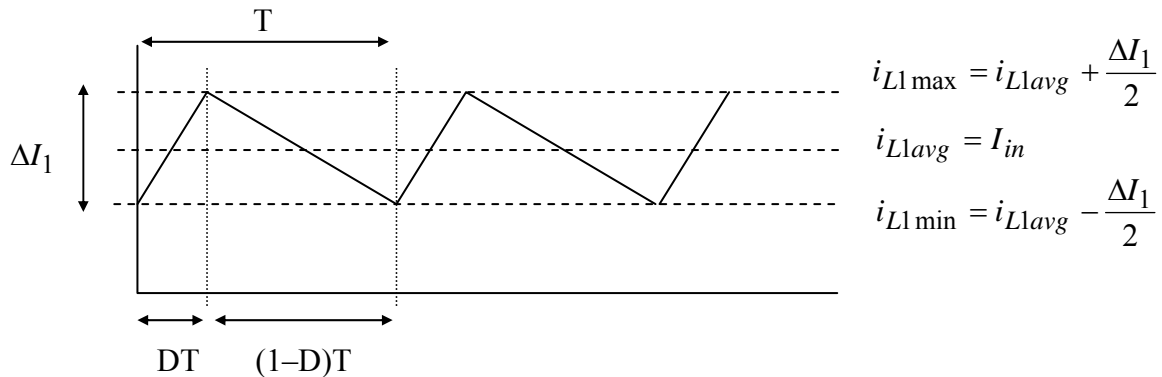

Figure 4. Inductor  $L_1$  Current Waveform for Continuous Conduction

From Figure 4 and Equation (3), when the switch is open (i.e.,  $L_1$  is “discharging”),

$$\frac{di_{L1}}{dt} = \frac{-V_{out}}{L_1},$$

so that

$$\Delta I_1 = \frac{V_{out}}{L_1} \bullet (1-D)T = \frac{V_{out}(1-D)}{L_1 f}, \quad (8)$$

where  $f$  is the switching frequency.

The boundary of continuous conduction for  $L_1$  is when  $i_{L1 \min} = 0$ , as shown in Figure 5.

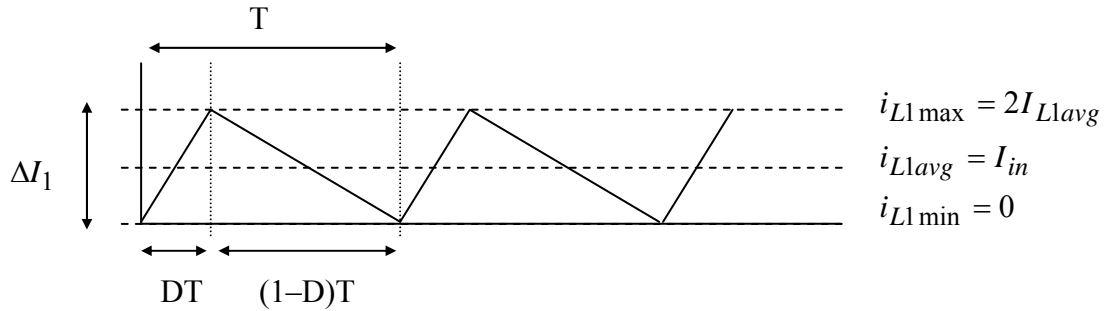

Figure 5. Inductor  $L_1$  Current at the Boundary of Continuous Conduction

Thus, at the boundary,

$$2I_{in} = \frac{V_{out}(1-D)}{L_{boundary} f}, \quad (9)$$

so that

$$L_{boundary} = \frac{V_{out}(1-D)}{2I_{in} f} = \frac{DV_{in}}{1-D} \bullet \frac{(1-D)}{2I_{in} f} = \frac{DV_{in}}{2I_{in} f}. \quad (10)$$

As  $D$  approaches unity,

$$L_1 > \frac{V_{in}}{2I_{in} f} \quad (11)$$

will guarantee continuous conduction. Note in (10) and (11) that continuous conduction can be achieved more easily when  $I_{in}$  and  $f$  are large.

The graph of  $i_{L2}$  is shown in Figure 6.

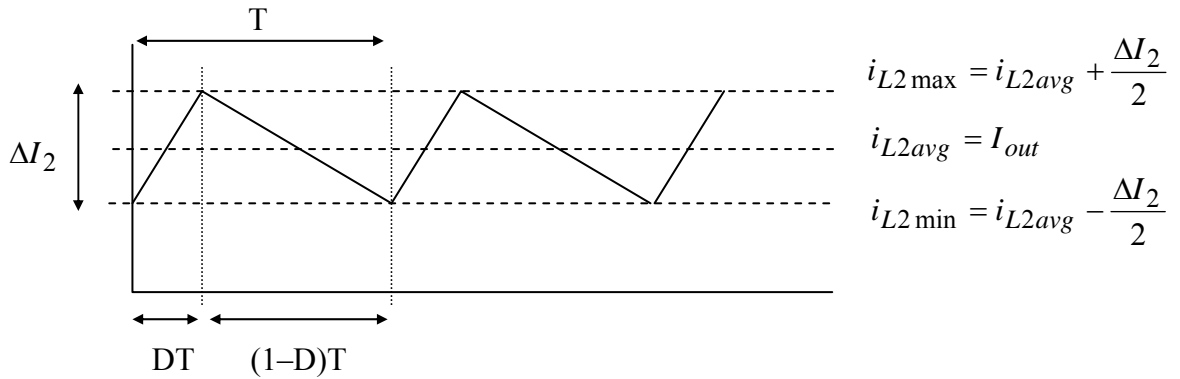

Figure 6. Inductor  $L_2$  Current Waveform for Continuous Conduction

From Figures 2b and 6, when the switch is open (i.e.,  $L_2$  is “discharging”),

$$\frac{di_{L2}}{dt} = \frac{-V_{out}}{L_2} = \frac{\Delta I_2}{(1-D)T},$$

so that

$$\Delta I_2 = \frac{-V_{out}(1-D)T}{L_2} = \frac{-V_{out}(1-D)}{L_2 f}, \tag{12}$$

where  $f$  is the switching frequency.

The boundary of continuous conduction for  $L_2$  is when  $i_{L2\min} = 0$ , as shown in Figure 7.

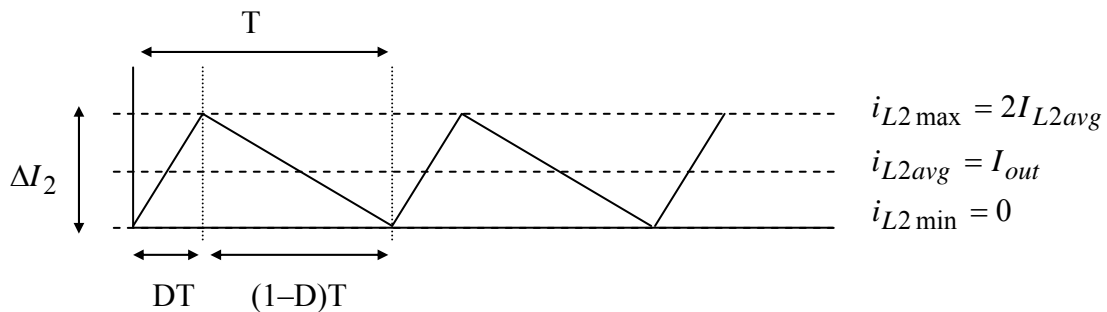

Figure 7. Inductor  $L_2$  Current at the Boundary of Continuous Conduction

Thus, at the boundary,

$$2I_{out} = \frac{V_{out}(1-D)}{L_{2boundary} f}, \tag{13}$$

so that

$$L_{2boundary} = \frac{V_{out}(1-D)}{2I_{out}f} . \quad (14)$$

Since the maximum value of (14) occurs at  $D \rightarrow 0$ ,

$$L_2 > \frac{V_{out}}{2I_{out}f} \quad (15)$$

will guarantee continuous conduction for  $L_2$  for all  $D$ . Note in (14) and (15) that continuous conduction can be achieved more easily when  $I_{out}$  and  $f$  are large.

### ***Current Ratings for Continuous Conduction Operation***

Continuous current waveforms for the MOSFET, the capacitors, and the diode in continuous conduction are shown in Figure 8 on the following page. Corresponding waveforms for the inductors were shown previously in Figures 4 and 6.

Following the same formulas and reasoning used for the buck converter, conservative current ratings for components  $L_1$ ,  $L_2$ , the MOSFET, and the diode follow.

For  $L_1$ , using Figure 5,

$$I_{L1,rms,max}^2 = I_{in}^2 + \frac{1}{12}(2I_{in})^2 = I_{in}^2 \left(1 + \frac{1}{3}\right),$$

so that

$$I_{L1,rms,max} = \frac{2}{\sqrt{3}} I_{in} . \quad (16)$$

Similarly, for  $L_2$ , using Figure 7,

$$I_{L2,rms,max} = \frac{2}{\sqrt{3}} I_{out} . \quad (17)$$

**EE462L, Power Electronics, DC-DC SEPIC Converter**  
Version March 1, 2013

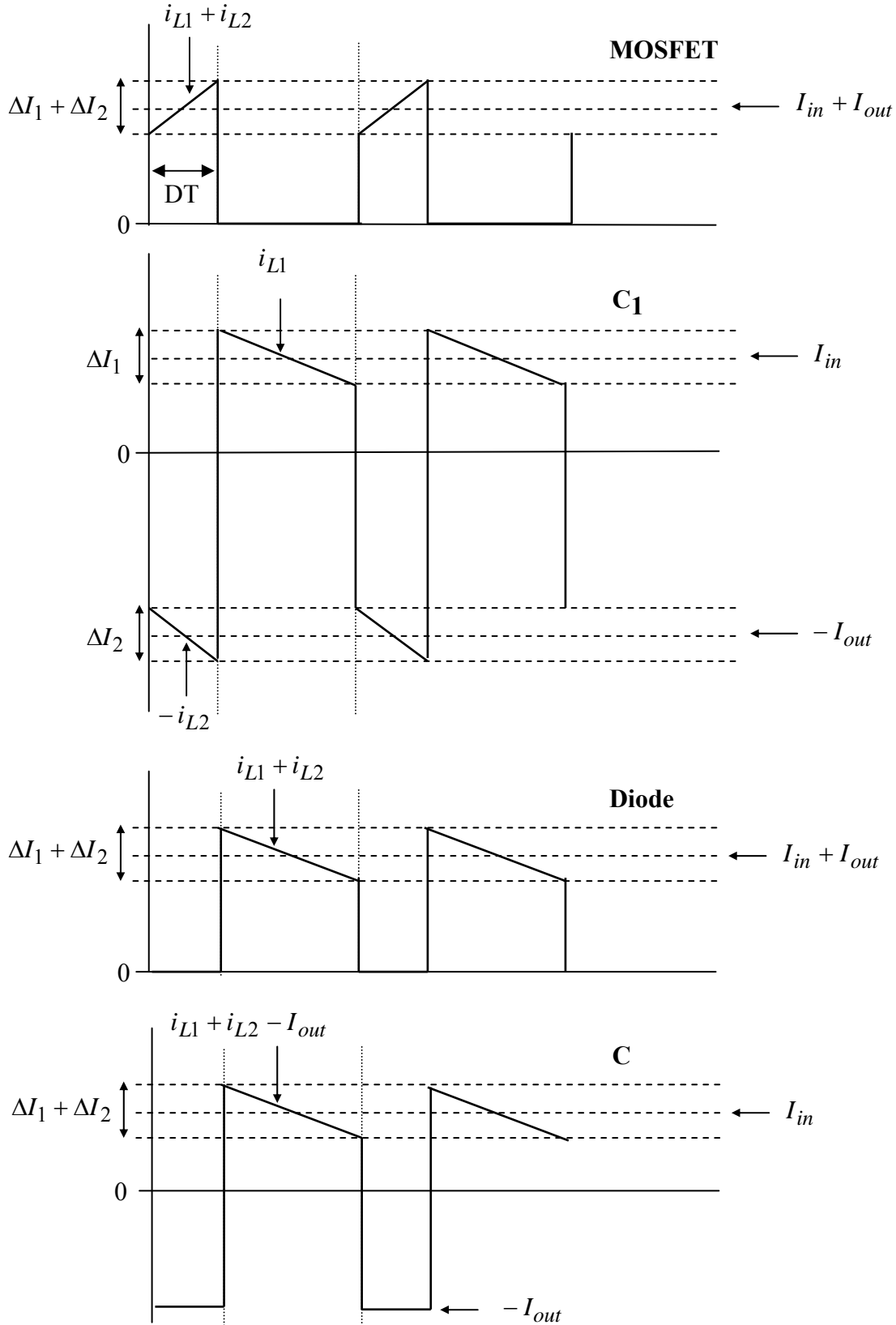

Figure 8. Current Waveforms for MOSFET, Capacitors, and Diode in Continuous Conduction

For the MOSFET and diode, assuming large worst-case  $D$ , and using Figure 8,

$$I_{MOSFET,rms,max} = \frac{2}{\sqrt{3}}(I_{in} + I_{out}), \quad (18)$$

$$I_{Diode,rms,max} = \frac{2}{\sqrt{3}}(I_{in} + I_{out}). \quad (19)$$

For  $C_1$  and  $C$ , using Figure 8,

$$I_{C1,rms,max} = \frac{2}{\sqrt{3}}I_{in} \text{ or } \frac{2}{\sqrt{3}}I_{out}, \text{ whichever is larger.} \quad (20)$$

$$I_{C,rms,max} = \frac{2}{\sqrt{3}}I_{in} \text{ or } I_{out}, \text{ whichever is larger.} \quad (21)$$

### ***Voltage Ratings for Continuous Conduction Operation***

Referring to Figure 2b, when the MOSFET is open, it is subjected to  $(V_{in} + V_{out})$ . Because of the usual double-voltage switching transients, the MOSFET should therefore be rated  $2(V_{in}+V_{out})$ .

Referring to Figure 2a, when the MOSFET is closed, the diode is subjected to  $(V_{in} + V_{out})$ . The diode should be rated at  $2(V_{in}+V_{out})$ .

Note – “stiff” voltages across capacitors  $C_1$  and  $C$  will help hold down overshoots on the MOSFET and diode in this circuit.

### ***Output Capacitor Voltage Ripple***

The maximum ripple voltage calculation for output capacitor  $C$  follows from Figure 8 and is the same as for the boost converter, namely

$$\Delta V = \left| \frac{\Delta Q}{C} \right| = \frac{I_{out}DT}{C} = \frac{I_{out}D}{Cf}.$$

The maximum peak-to-peak ripple thus occurs as  $D \rightarrow 1$  and is

$$\Delta V_{max} = \frac{I_{out}}{Cf}. \quad (22)$$

Comparing the current graphs for  $C_1$  and  $C$  in Figure 8 during the  $DT$  “switch closed” period, it can be seen graphically that the ripple voltage on  $C_1$  and  $C$  are the same, i.e. Equation (22).



## The Experiment

**Important – to avoid excessive output voltages, always keep a load attached to the converter when it is operating. Do not exceed 90V on the converter output.**

1. Reconfigure the buck or boost components according to Figure 1 in this document. Secure new components  $C_1$  and  $L_2$ . Make all connections. Capacitor  $C_1$  is bipolar (i.e., not polarized).
2. Connect the MOSFET Firing Circuit to your converter, **using short leads**. The firing circuit is the same as for the Boost Converter. Double check your range of D.
3. Before connecting power, **make sure that a  $5\Omega$  ceramic power resistor is connected as a load**. View  $V_{GS}$  on Channel #1, adjust D to the minimum setting, and F to approximately 90kHz. Connect Channel #2 to view  $V_{DS}$ . Set the trigger for Channel #1.

**Important Note: the first time you energize your converter, feed the 120/25V transformer through a variac, so that you can SLOWLY increase the voltage from zero and read the variac ammeter to detect short circuits before they become serious.** A common problem is to have the MOSFET in backward, so that its internal antiparallel diode creates a short circuit. The ammeter on the variac is an excellent diagnostic tool. Once you are convinced that your circuit is working correctly, the variac is then optional. **Remember – your boost converter requires DC input power from a DBR.**

Does your circuit have a short? If so, do the following:

1. Make sure that your MOSFET is not connected backwards.
  2. Observe  $V_{GS}$  on the MOSFET as you vary D and F. Does the waveform look correct?
  3. Unplug the wall wart. Does the short circuit go away? If not, your MOSFET may be shorted – so, disconnect the MOSFET from the converter, and perform the voltage-controlled resistance test on the MOSFET.
4. Connect a  $25V_{ac}$  transformer to a DBR. Connect the DBR to your SEPIC converter, **keeping the wires short (i.e., 3” or less)**. Then, energize the  $25V_{ac}$  transformer and DBR. If using a variac, adjust the variac so that  $V_{ac}$  of the transformer is approximately 27-28V.
  5. With  $F \approx 90kHz$ , slowly increase D from its smallest value to obtain  $V_{out} = 10, 20$  (within  $\pm 2V$ ), while recording D,  $V_{in}$ ,  $V_{out}$ ,  $I_{in}$ ,  $I_{out}$ . Note by viewing  $V_{DS}$  whether or not the circuit is in continuous current operation. **For the 20V condition, compute input and output powers and efficiency. Do not go above 20V with the  $5\Omega$  load.**

## EE462L, Power Electronics, DC-DC SEPIC Converter

Version March 1, 2013

6. Turn off the DBR, and connect a **10 $\Omega$  ceramic power resistor** as a load. Continue the experiment as before, adjusting D, and taking D,  $V_{in}$ ,  $V_{out}$ ,  $I_{in}$ ,  $I_{out}$  readings with  **$V_{out} = 30, 40V$ . Do not go above 40V with the 10 $\Omega$  load.**
7. Turn off the DBR, and connect a **120V, 150W light bulb** as a load. Continue the experiment, adjusting D, taking D,  $V_{in}$ ,  $V_{out}$ ,  $I_{in}$ ,  $I_{out}$  readings with  **$V_{out} = 50, 60, 70, 80, 90V$** . For the 90V case, save a screen snapshot of  $V_{DS}$  that shows the peak value.
8. For your report, compute converter efficiencies for the **20V, 40V, and 90V** conditions. Also, plot actual and theoretical  $V_{out}/V_{in}$  versus D on one graph.

The following **optional** steps are to be performed with solar panels as the power source and with good sun (i.e., panel short circuit current of 3.5A or more). The panel voltage that you measure should be “at the panel” (i.e., the left-most analog voltmeter)

9. Note the sky conditions. Connect a solar panel pair directly to a 120V, 150W light bulb. Measure panel voltage, panel current, and compute solar panel output power.
10. Next, insert the SEPIC converter between the panel pair and 120V light bulb. With  $F \approx 90kHz$ , sweep D over its range to measure and plot the I-V and P-V characteristics of the panel pair. Record the maximum power value.

### Parts List

- Series capacitor, Xicon 33 $\mu F$ , 50V, high-frequency bipolar (i.e., not polarized), rated 14A peak-to-peak ripple current (Mouser #140-BPHR50V33)
- Second inductor like the one in the buck converter
- Second heat sink like the one in the buck converter
- Second nylon screw and lock nut like the one in the buck converter
- Two additional, 2-terminal, 30A terminal blocks (these may not be needed by students who are building minimum footprint circuits)
- 8” nylon cable tie (in student parts bin)

### Extra parts

**For the student parts bin and screw cabinet, at least**

- 5 of the 250V MOSFETs (individually bagged)
- 5 of the 200V, 16A ultrafast rectifiers
- 5 of the DC jacks
- 5 of the 10k $\Omega$  audio taper and linear taper potentiometers
- 5 of the PWM modulator chips
- 5 of the inverting driver chips
- 5 of the 14-pin sockets
- 5 of the 8-pin DIP sockets
- 5 of the green plugs
- 10 of the #4-40 x 1” flat slotted nylon screws and lock nuts

**Plastic bags for parts**

- 6"x6", 4mil

**EE462L, Power Electronics, DC-DC SEPIC Converter**  
Version March 1, 2013

**Appendix**

Worst-Case Component Ratings Comparisons for DC-DC Converters

Converter Type	Input Inductor Current (Arms)	Output Capacitor Voltage	Output Capacitor Current (Arms)	Diode and MOSFET Voltage	Diode and MOSFET Current (Arms)
Buck	$\frac{2}{\sqrt{3}} I_{out}$	$1.5V_{out}$	$\frac{1}{\sqrt{3}} I_{out}$	$2V_{in}$	$\frac{2}{\sqrt{3}} I_{out}$
Boost	$\frac{2}{\sqrt{3}} I_{in}$	$1.5V_{out}$	$I_{out}$	$2V_{out}$	$\frac{2}{\sqrt{3}} I_{in}$
SEPIC	$\frac{2}{\sqrt{3}} I_{in}$	$1.5V_{out}$	$\max\left(\frac{2}{\sqrt{3}} I_{in}, I_{out}\right)$	$2(V_{in} + V_{out})$	$\frac{2}{\sqrt{3}} (I_{in} + I_{out})$

Additional Components for SEPIC Converter

Series Capacitor Voltage	Series Capacitor ( $C_1$ ) Current (Arms)	Series Capacitor ( $C_1$ ) Ripple Voltage (peak-to-peak)	Second Inductor ( $L_2$ ) Current (Arms)
$1.5V_{in}$	$\max\left(\frac{2}{\sqrt{3}} I_{in}, \frac{2}{\sqrt{3}} I_{out}\right)$	$\frac{I_{out}}{C_1 f}$	$\frac{2}{\sqrt{3}} I_{out}$

Comparisons of Output Capacitor Ripple Voltage

Converter Type	Volts (peak-to-peak)
Buck	$\frac{I_{out}}{4Cf}$
Boost	$\frac{I_{out}}{Cf}$
SEPIC	$\frac{I_{out}}{Cf}$

**EE462L, Power Electronics, DC-DC SEPIC Converter**

Version March 1, 2013

## Minimum Inductance Values Needed to Guarantee Continuous Current

Converter Type	For Continuous Current in the Input Inductor	For Continuous Current in L2
Buck	$L > \frac{V_{out}}{2I_{out}f}$	–
Boost	$L > \frac{V_{in}}{2I_{in}f}$	–
SEPIC	$L_1 > \frac{V_{in}}{2I_{in}f}$	$L_2 > \frac{V_{out}}{2I_{out}f}$