

Optoswitches, Optical Hybrids, and Custom Optical Assemblies

Specialty Lighting

Digital Imaging

Telecom

Sensors

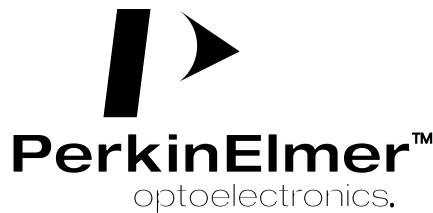

Optoswitches, optical hybrids, custom assemblies, photodiodes, phototransistors, IR emitters, and photoconductive cells for industrial, commercial, and consumer electronics applications.

PerkinElmer Optoelectronics has the distinction of being one of the foremost manufacturers in optoelectronics. Founded in 1947, PerkinElmer offers its customers over 35 years experience in the development and application of optoelectronic devices. The product line is one of the broadest in the industry, including a variety of standard catalog products as well as custom design and manufacturing capabilities. Approximately 75% of the products shipped are custom designed and tested to serve the needs of specific OEM applications.

Three basic objectives guide PerkinElmer's activities - **Service, Quality, and Technology**. Our outstanding engineering staff, coupled with the implementation of modern material control and manufacturing techniques, plus our commitment to quality, has gained PerkinElmer "certified" status with many major customers. Products are often shipped directly to manufacturing lines without need for incoming QC at the customer's facility. PerkinElmer's products are vertically integrated, from the growing of LED crystals, silicon die fabrication, package design, reliability qualification, to assembly. Vertical integration is your assurance of consistent quality.

Recognizing the need for low-cost manufacturing to serve world markets, PerkinElmer expanded its manufacturing/assembly operations into the Far East more than 20 years ago. The combination of strong technology in processing at the St. Louis headquarters and low-cost assembly operations in the Far East has allowed PerkinElmer to effectively serve all markets, worldwide. PerkinElmer provides optical sensors, IR emitters and subassemblies for such diverse applications as street light controls, cameras, smoke alarms, business machines, automotive sensors, and medical equipment.

For pricing, delivery, data sheets, samples, or technical support please contact your PerkinElmer Sales Office or direct your questions directly to the factory.

PerkinElmer Optoelectronics
10900 Page Avenue
St. Louis, Missouri 63132 USA
Tel: (314) 423-4900 Fax: (314) 423-3956

Copyright 2001 by
PerkinElmer Optoelectronics
All rights reserved
www.perkinelmer.com/opto

Table of Contents

Custom and Semi-Custom Optoswitches	1
Questions to Consider on Your Custom Assemblies	2
Overview of Custom Assembly Capabilities	3
Custom Modification to Standard Optoswitches	3
Full Custom Optoswitch Designs	4
Silicon Detector Arrays	5
Optical Encoder Assemblies	6
Custom Photocells and Photocell Assemblies	7
Case Studies of Custom Design Solutions	8
Optical Probes for a Teaching Lab	8
Sensors for X-Ray Detection	9
Optical Sensing Block for Medical Diagnosis	10
Optical Control of Photocopy Quality	11
Paper Sensing in Photocopy Machines	12
Optoswitch Selection Guide	13
Optoswitch Typical Applications	15
Why Use Optical Switches?	15
General Characteristics and Features	15
Standard Reflective Optoswitch Overview	17
Reflective Optoswitches	22
Standard Transmissive Optoswitch Overview	28
Transmissive Optoswitches	32

Part Number Index

PART NO.	PAGE
VTL11D1-20	32
VTL11D3	32
VTL11D3-20	32
VTL11D5-20	32
VTL11D6-20	32
VTL11D7	32
VTL11D7-20	32
VTL13D1-20	34
CTL13D3	34
VTL13D3-20	34
VTL13D5-20	34
VTL13D6-20	34
VTL13D7	34
VTL13D7-20	34

PART NO.	PAGE
VTL23D0A21	36
VTL23D0A22	36
VTL23D1A00	36
VTL23D1A22	36
VTL23D2A00	36
VTL23D3A00	36
VTR16D1	22
VTR17D1	24
VTR24F1	26

Custom and Semi-Custom Optoswitches

Upon request, and where sufficient quantities are involved, PerkinElmer Optoelectronics will test standard parts to your unique set of specifications. Testing parts under actual operating conditions gives you the benefit of predictable performance in your application.

PerkinElmer offers a broad line of standard optoswitches in a wide variety of packages and sensitivities. Nevertheless, some applications demand a totally custom device. Recognizing this real need, PerkinElmer's engineering and sales departments are experienced in working with the customer from initial concept through design, prototype, and volume production.

A custom design usually requires the commitment of valuable resources. PerkinElmer reviews requests for custom devices on a case by case basis and reserves the right to decide if the business potential warrants the undertaking of such a project. The customer may be asked to share in the expense of development.

PerkinElmer has designed and fabricated custom products for many companies. Our staff can work closely with you and protect your proprietary information.

Your inquiries to PerkinElmer should include electrical, environmental, and mechanical requirements. Also, information on anticipated volumes, price objectives, and lead times is needed since these often determine the choices of design and tooling. "Questions to Consider..." on the following page outlines key questions which have to be answered.

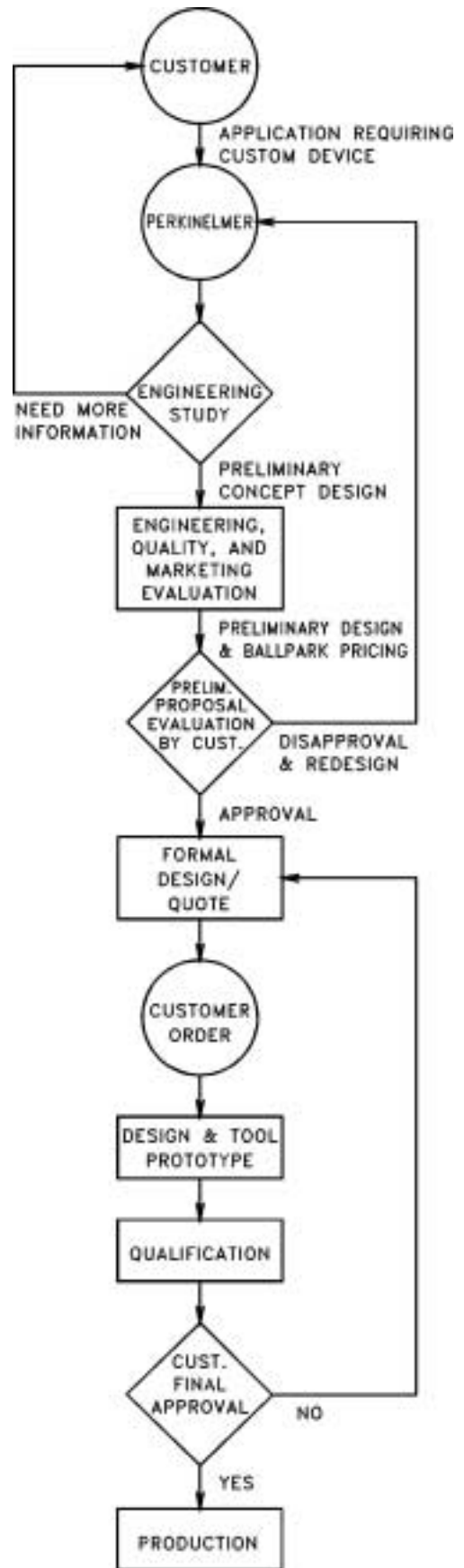

Questions to Consider on Your Custom Assemblies

This outline is provided to assist you in supplying the basic information needed to respond to your inquiry. Upfront information will help expedite your answers.

Application

Describe the application

Indicate general nature of application
(consumer, business, industrial, medical,
aerospace, military)

Input/output circuits and waveforms

If a target is being sensed:

What is the target made of?

What is the size of target?

What is the relative positions between
target and sensor?

Provide samples of hardware and devices if possible

Electrical Requirements

Voltage supply, min./max. limits

Maximum voltage device must withstand

Maximum/minimum supply current

Required output signal, best & worst case

Ambient light condition

DC or pulsed operation

Electrical noise environment (EMI/RFI)

Duty Cycle

Used for how many hours each day?

Number of days/week in normal operation

Electrical on-time

Electrical off-time

Environmental Requirements

Used indoors or outdoors?

Temperature range (operating and storage)

Humidity/moisture environment

Shock/vibration requirements

Required operating life

Solvents device may be exposed to

Static electricity requirements

Other requirements (pressure, salt water exposure, etc.)

Mechanical Requirements

Provide sketch

Can we propose changes to the physical layout?

How is device to be mounted?

How will you handle and install our device in your
production line?

Volume, Cost, and Lead Time Requirements

Total program volume

Peak delivery date requirement

Price Objectives

Development/in production lead times

Timing

Prototypes needed by: _____

Production quantities needed by: _____

Name of Engineering Contact: _____

Phone: _____

Name of Quality Contact: _____

Phone: _____

Name of Purchasing Contact: _____

Phone: _____

Overview of Custom Assembly Capabilities

Custom Modification to Standard Optoswitches

PerkinElmer can design and build a custom optoswitch that meets the exact requirements of your application. Our capabilities include:

- *Testing a standard optoswitch to your unique electrical/optical requirements.*
- *Adding lead extensions to the standard optoswitch, with or without connectors.*
- *Offering special performance emitters and detectors in standard housings.*
- *Mounting optoswitches on a printed circuit board with or without other components.*
- *Providing a sub-assembly that is 100% tested to your specifications.*

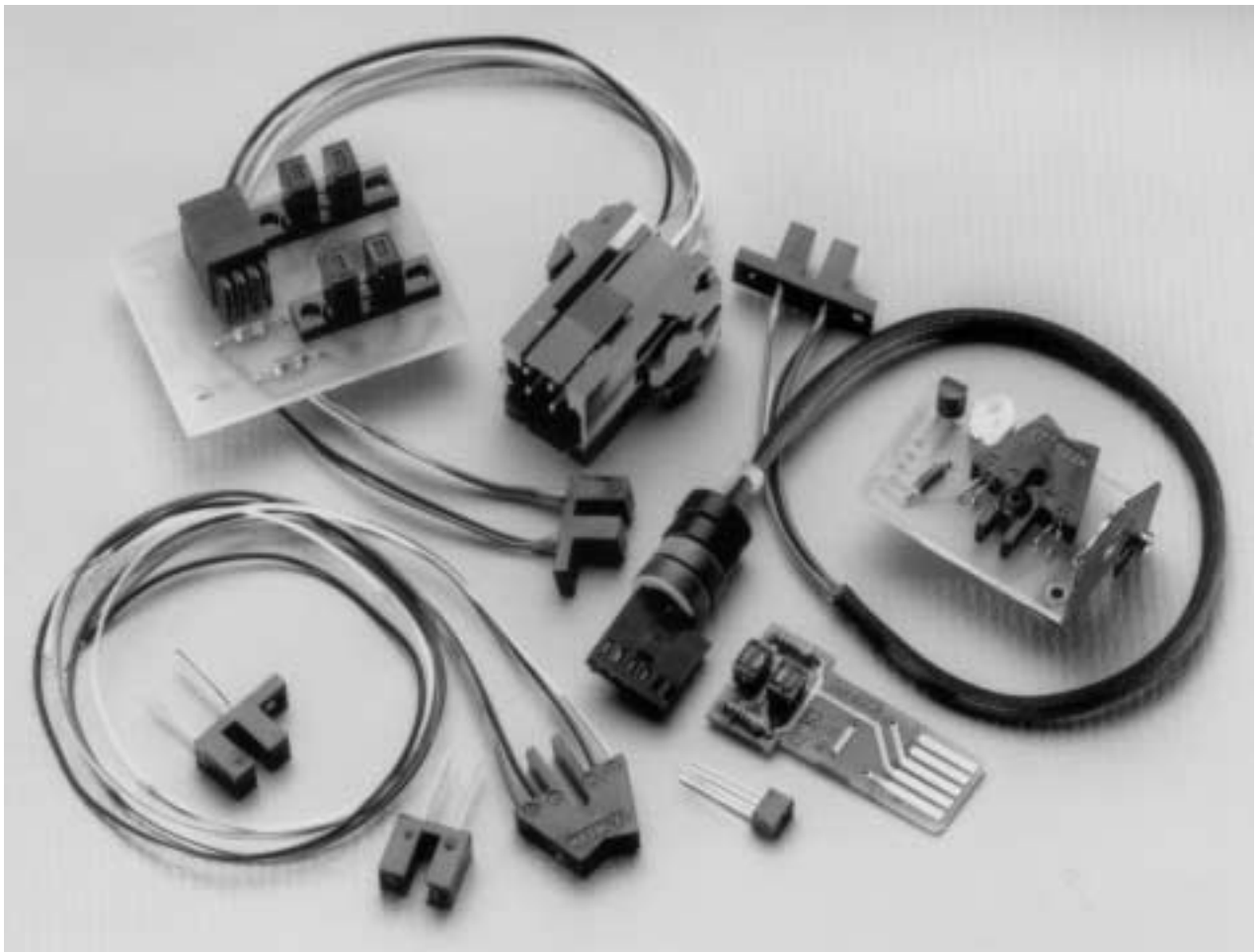

Overview of Custom Assembly Capabilities

Full Custom Optoswitch Designs

Full custom designs fill the demanding requirements of higher volume applications. These designs often include the:

- *Design and tooling of a custom package geometry to house active optoelectronic components to meet space limitations.*
- *Special selection of emitters and detectors uniquely suited for the application.*
- *Complete design of a sub-assembly with input/output circuitry, special filters, lenses, cable harnesses, and terminations to provide a system solution to your requirements.*

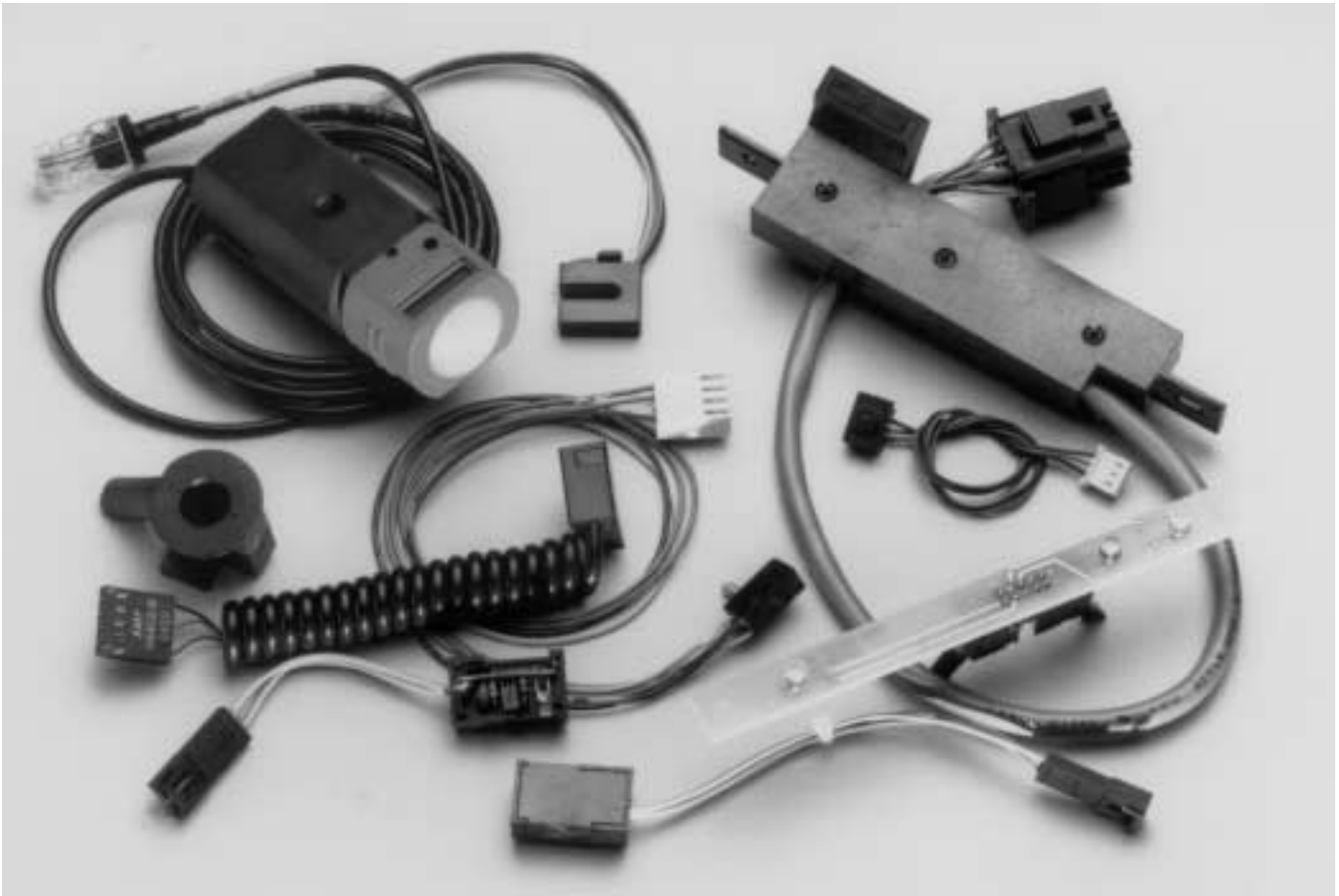

Overview of Custom Assembly Capabilities

Silicon Detector Arrays

PerkinElmer produces a complete line of multielement silicon detectors. Consult your local sales representative or the factory to determine whether one of our pre-tooled arrays will meet your specific needs, or if a custom design approach is required. Custom detector arrays allow a wide range of choice in:

- *The number of elements.*
- *The geometry and positioning of the elements.*
- *Construction (monolithic, hybrid, or a combinations of the two).*
- *Packaging (hermetic, cast/molded, conformal coat, etc.).*
- *Electro-optical characteristics: sensitivities, spectral response, response times, and electrical characteristics.*



Overview of Custom Assembly Capabilities

Optical Encoder Assemblies

PerkinElmer produces custom designed detector arrays for optical encoder applications. Design options include:

- *Photodiode, phototransistor, and photodarlington detector elements.*
- *One piece monolithic chip arrays.*
- *Multiple chip hybrid arrays.*
- *Hybrid packages.*
- *Unique mounting configurations.*

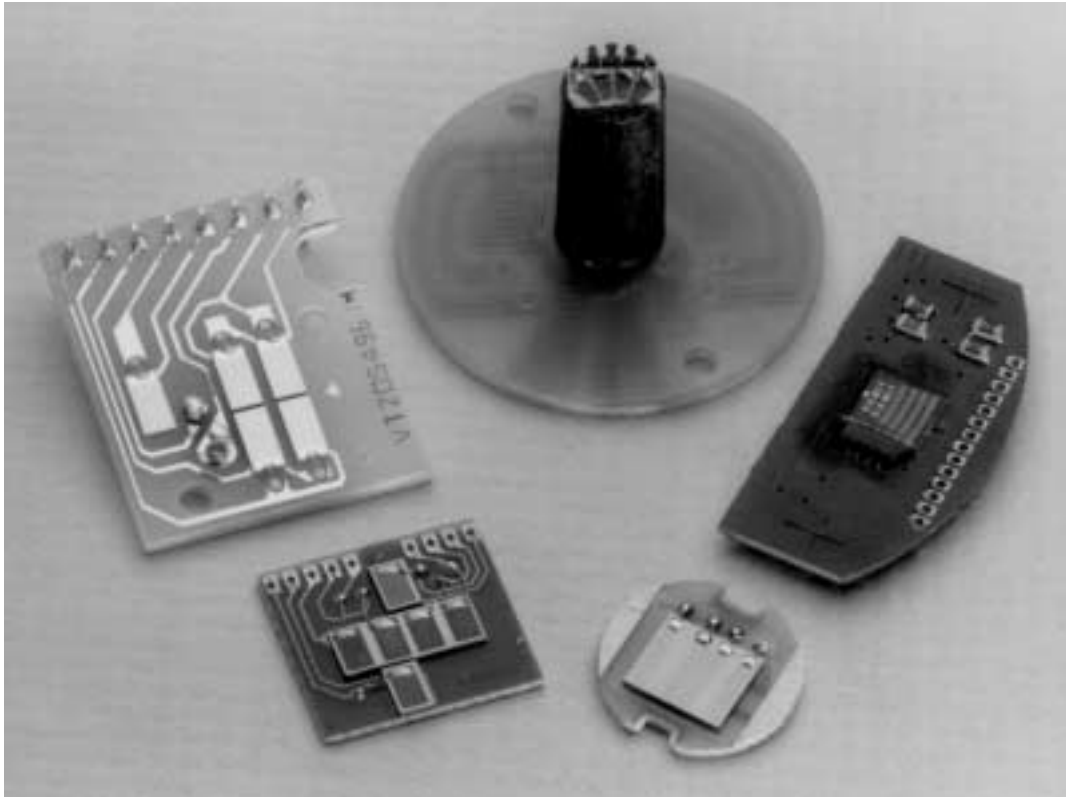

Overview of Custom Assembly Capabilities

Custom Photocells and Photocell Assemblies

Photocells are low cost light detectors. They have a very wide dynamic range and can detect low illumination levels. PerkinElmer is the world leader in CdS and CdSe photoconductive cells. Besides offering a wide range of standard products, PerkinElmer can:

- *Select a standard device tested to your unique electrical/optical requirements.*
- *Develop a totally custom device — including hybrid designs.*
- *Provide 100% tested custom assemblies.*



Case Studies of Custom Design Solutions

Optical Probes for a Teaching Lab

There is growing concern over the science and math skills of today's students. So, the emphasis is to present these subjects in formats that are more interesting for the student and easier for the teacher.

A new learning tool is available for kindergarten through college students. It's a microcomputer-based laboratory consisting of a base unit, with various modules and probes, which attaches to a personal computer and acts as the hub of a science lab. It helps to learn and to teach science and math in new, more interesting ways by exploring questions to reinforce the theory behind the answers. The modules and probes connect to the base PC and allow for measurement of temperature, light, pH, distance, etc.

PerkinElmer Optoelectronics provides the light measurement probes used with this system. Two light probes are available: a photometric probe and radiometric probe.

The photometric probe uses a photometrically corrected photodiode that provides a spectral response to light similar to the human eye. The radiometric probe offers a radiometrically corrected photodiode providing an absolute measurement of light intensity and a nearly uniform sensitivity across the entire visible spectrum.

These assemblies consist of a custom designed photodiode chip and a custom glass filter in a hermetic package. This is assembled into a waterproof housing, with a cable assembly providing connection to a specific module. The finished assemblies are individually computer calibrated using a closely controlled light source. A filter holder is also provided, allowing the introduction of additional filters into the light path.

PerkinElmer is a certified supplier for this assembly. The units are shipped directly to retail distribution with no need for incoming Q.C. at the customer's O.E.M. facility.



Case Studies for Custom Design Solutions

Sensors for X-Ray Detection

X-Ray security screening systems are seen in use wherever high security and rapid screening of large items are required. This includes airports, customs facilities, nuclear power plants, correctional institutions, corporate mailrooms, and government buildings. These systems allow complete screening of luggage, parcels, boxes, crates, etc.

Security screening systems feature powerful X-Ray units capable of penetrating up to 17 mm of steel. The x-rays are sensed by spatial arrays of photodiode detectors, positioned to allow two dimensional sensing. Items passing through a tunnel opening are scanned and imaged, with the images displayed on a video monitor in black and white or in computer enhanced color.

PerkinElmer Optoelectronics provides linear X-Ray detector arrays for these security systems. These arrays produce the line sensing capability used for the detection of the X-Ray images with less than 0.10 mR total exposure.

Each PerkinElmer detector array consists of four, eight element common cathode photodiode arrays positioned end to end, providing 32 in-line elements, diebonded to a printed circuit board. The photodiode arrays are custom designed specifically for this application and are 100% tested for light current and dark current. The arrays are also 100% tested for response uniformity, which is the ratio of the highest to lower light currents between the 32 detector elements. The printed circuit board assemblies are manufactured to close dimensional tolerances and are stackable end-to-end.

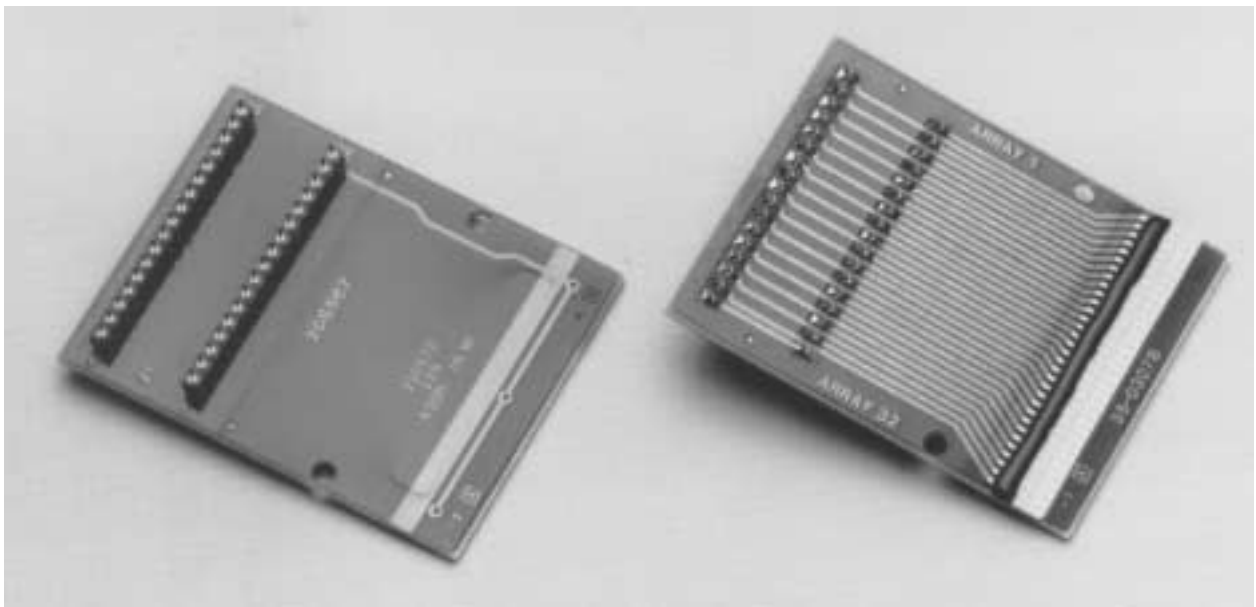

Case Studies of Custom Design Solutions

Optical Sensing Block for Medical Diagnosis

PerkinElmer Optoelectronics supplies sophisticated products to medical electronics. One example is a pair of hybrid packaged emitter-detector arrays used in a medical microbiology testing system. This *in vitro* system is fully automated and offers the fastest microbiological testing available. It shortens a patient's hospital stay and allows the physician to accurately and quickly select the most effective and least expensive antimicrobial.

This automated diagnostic system has four components:

1. Disposable test kits, including plastic cards used to identify organisms and appropriate antimicrobials.
2. An instrument cabinet, containing a computer, a mechanism for inoculating test cards, and a reader/incubator that houses the PerkinElmer emitter and detector assemblies used to measure the samples.
3. A data terminal and keyboard for communicating with and controlling the system.

4. A printer for automatically reporting final test results.

Basically, the PerkinElmer detector assembly consists of a hybrid array of precisely aligned phototransistor chips. These chips identify the test card, and sense the attenuation of light passing through test card wells containing enriched media and sample organisms. The light source is a PerkinElmer emitter assembly consisting of a hybrid array of precisely aligned light emitting diodes (LEDs). The testing system controls temperature and timing exactly. The plastic cards are automatically scanned hourly. The onboard computer interprets the measurement results and produces diagnostic reports.

PerkinElmer's role in the design and manufacture of these critical emitter and detector assemblies centers on quality workmanship and specially selected discrete and multi-element opto chips. A comparator is used for the precise alignment of the emitter and detector chips on metallized ceramics, as well as for the precise alignment of the chrome etched aperture cover glasses. The assemblies then undergo extensive 100% computerized testing to assure performance.



Case Studies of Custom Design Solutions

Optical Control of Photocopy Quality

Sensing toner density in photocopiers is a major application of optosensors, PerkinElmer Optoelectronics has years of experience in helping customers with high performance toner control sensors.

For example, one photocopier customer had an infrared density control that had problems with accuracy and repeatability. A density control reads a test patch on the photoreceptor and reports to the system microprocessor, which adjusts toner delivery and electrostatics.

We analyzed the existing assembly and determined that certain aspects of optical performance had not been considered in the original design. Based on these findings, the optical housing was retooled to perform to specification.

PerkinElmer also solved several circuit problems. Temperature stability was improved by developing a higher shunt impedance detector. We found that stability could be further improved by changing the value of the nulling pot for one of the op-amps. Noise problems were traced to

an onboard voltage regulator. PerkinElmer recommended changing to a new vendor and the problem was eliminated.

An additional problem occurred when the assembly's PC board was bolted to a calibration fixture. The calibration readings tended to shift due to the stresses applied to the plastic packaged op-amp as the PC board was secured. Changing from a plastic to a rigid ceramic package IC resolved this problem, assuming that the sensor would remain in calibration during testing, shipping and handling.

Prior to PerkinElmer's improvements, the customer had begun a major design program to add diagnostic features onboard, allowing their servicemen to perform field calibration. However, the customer's field service calls, and the major design program was halted. This allowed our customer to remain with the original design, and eliminate calibration in the field—producing significant dollar savings.

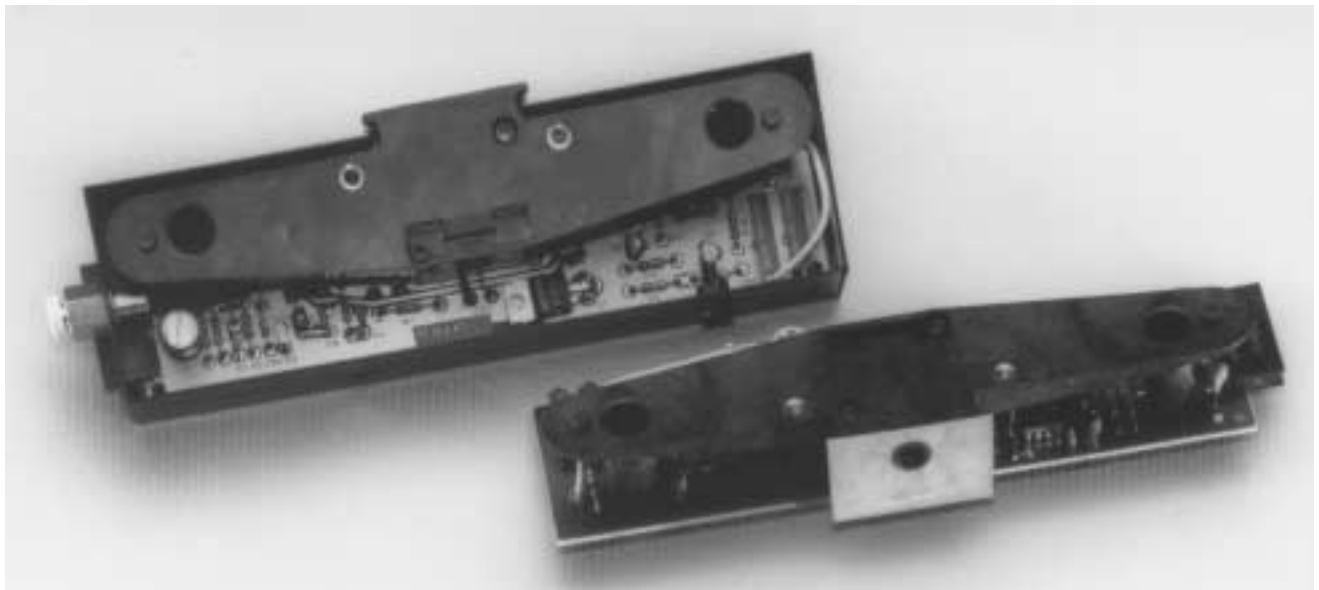

Case Studies of Custom Design Solutions

Paper Sensing in Photocopy Machines

Paper is fed through a wide variety of office copiers and printers. Automatic paper handlers need to sense the presence/absence and position of the paper at the entry/exit ports of each operation in the equipment. Reflective sensors like PerkinElmer Optoelectronics' VTR24F1 are often used because they are non-contact sensors and don't interfere with the travel of paper through the machine. The development of the original custom version of this sensor is a prime example of how PerkinElmer can work with a customer from design conception through final production.

The customer for this product originally came to us with what appeared to be a simple design request: design a low cost sensor to meet a limited number of simple criteria. The finished device was to sense white paper at a fixed distance from the sensor. The signal level change had to fall within a certain range. We were given a target price and a maximum physical size for the sensor.

The sensor was designed and demonstrated. It met all design and cost goals. Tooling for the sensor case was committed and, upon completion, pilot production devices were built. However, by the time

the evaluation was completed, the customer discovered that they had missed some critical details in the original specification. They determined that sensors would be needed in a number of additional locations within the machine and each had a different spacing between sensor and paper. They also determined that the sensor should "trip" its output within a certain range (± 2 mm) of paper entry into a specified target area. Finally, it was required that black paper should be as detectable as white paper. In total, parameters were added which required 32 separate tests to verify function under all operating conditions.

A redesign was done by PerkinElmer and all of the new specs were met. A special computerized test was designed to perform all 32 tests—quickly. As the product was moved into production, the additional costs were gradually reduced through process design modification and the unit price returned to the original goal—in spite of the large number of changes. Today, the unit price is lower than the original goal and performance has been proven through hundreds of thousands of parts and years of service without a failure.

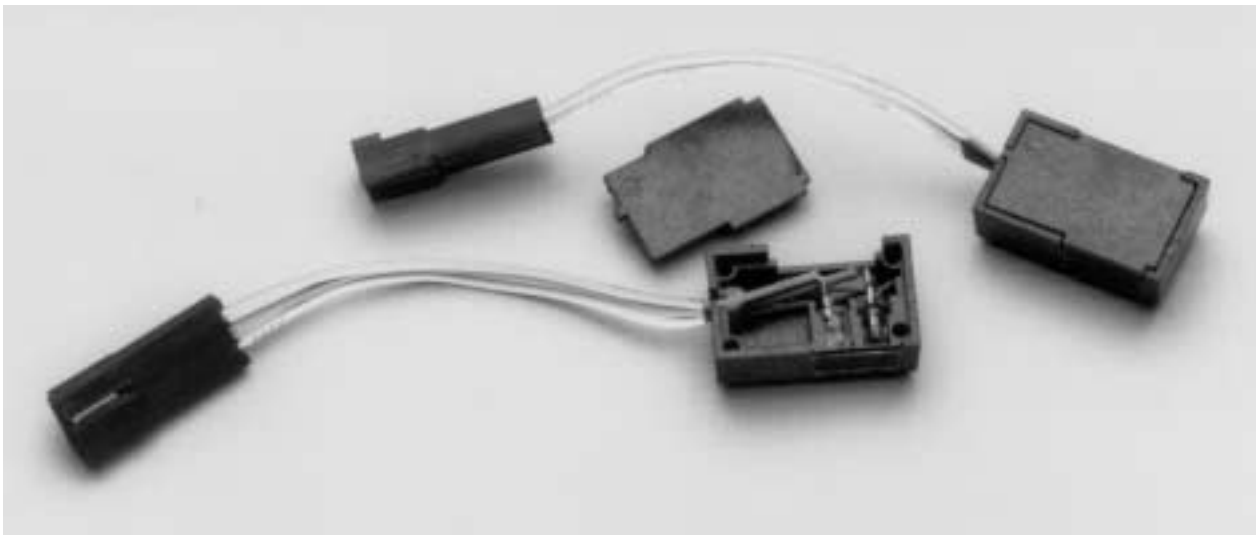

Standard Optoswitch Selection Guide

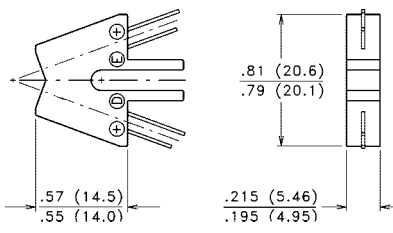
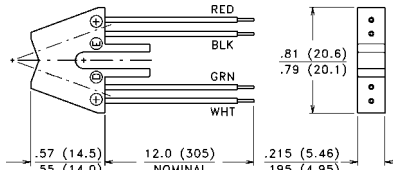
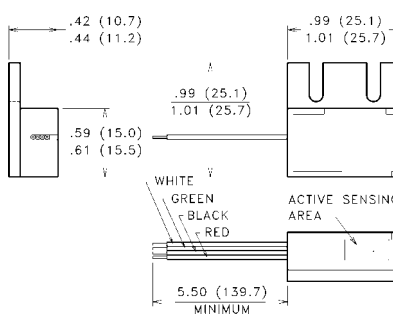
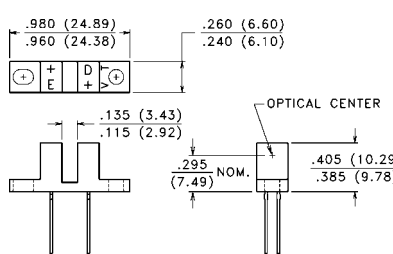
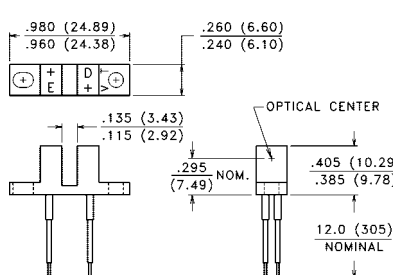
PACKAGE OUTLINE inch (mm)	PART NO.	FEATURES	PAGE
 <p>Arrow Retro With PC Board Mount Leads</p>	VTR16D1	LED Emitter Phototransistor Detector	24
	VTR16E1	LED Emitter Photodarlington Detector	24
 <p>Arrow Retro With Flying Leads</p>	VTR17D1	LED Emitter Phototransistor Detector	26
	VTR17E1	LED Emitter Photodarlington Detector	26
 <p>"Matchbox" Retro With Flying Leads</p>	VTR24F1	LED Emitter Photodarlington Detector Long Sensing Range	28
 <p>Slotted Switch With P.C.B. Mount Leads</p>	VTL11D1 VTL11D3 VTL11D7	LED Emitter Phototransistor Detector	34
	VTL11D1-20 VTL11D3-20 VTL11D5-20 VTL11D6-20 VTL11D7-20	LED Emitter Phototransistor Detector 20 mil Emitter Aperture	34
 <p>Slotted Switch With Flying Leads</p>	VTL13D1 VTL13D3 VTL13D7	LED Emitter Phototransistor Detector	36
	VTL13D1-20 VTL13D3-20 VTL13D5-20 VTL13D6-20 VTL13D7-20	LED Emitter Phototransistor Detector 20 mil Emitter Aperture	36

Standard Optoswitch Selection Guide

PACKAGE OUTLINE inch (mm)	PART NO.	FEATURES	PAGE
<p>Slotted Switch With P.C.B. Mount Leads</p>	<p>VTL23D0A21 VTL23D0A22 VTL23D1A00 VTL23D1A22 VTL23D2A00 VTL23D3A00</p>	<p>LED Emitter Phototransistor Detector</p>	<p>38</p>
<p>Slotted Switch With P.C.B. Mount Leads</p>	<p>—</p>	<p>Consult PerkinElmer for Availability of Devices in this Package</p>	<p>—</p>

Optoswitch Typical Applications

Why Use Optical Switches?

Optical switches are used to provide non-contact motion or position sensing. Typical configurations include:

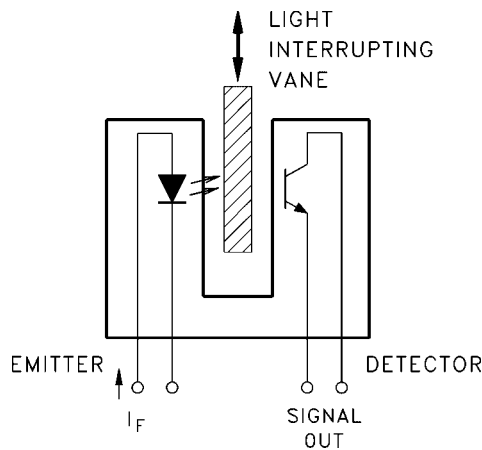

Slotted Switch

An object is detected when it enters the gap of the slotted switch and blocks the light path between the emitter and detector.

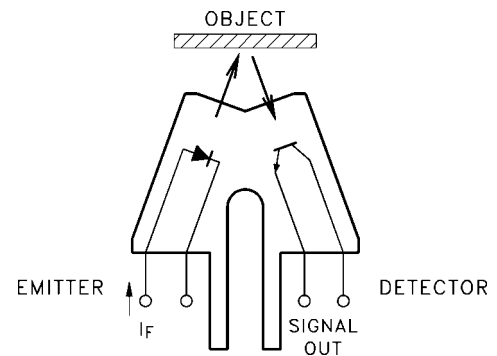

Retro Sensor

The retro sensor detects the presence of an object by emitting light and then looking for its reflection off of the object to be sensed.

General Characteristics and Features

- *Contain no mechanical parts to wear-out*
- *Provides non-contact sensing of objects*
- *Low power consumption, compatible with solid state electronics*
- *Low cost*
- *Capable of sensing any opaque object*
- *Small size*
- *Custom mechanical configurations available*
- *Can be specially selected or built to meet the requirements of your particular application*

Optoswitch Typical Applications

Optoswitches are often used in the following applications:

Printers and Typewriters

- *Paper Sensor*
- *Paper Feed Detector*
- *Imprinting Head Position Detector*
- *Initial Head Position Detector*

Floppy Disk Drives

- *Track Zero Sensor*
- *Index Sensor*
- *Disk-in Sensor*
- *Write Protect Sensor*

Vending Machines

- *Coin Sensor*
- *Detection of Goods*
- *Mechanism Position*

Facsimiles

- *Original Width Detection*
- *Initial Position Detection*
- *Final Position Detection*
- *Paper Out Detection*

Industrial

- *Rotational Speed/Position Detection (Encoder)*
- *Distance Detection*
- *Object Sensor*
- *Mechanism Position Detection*

VHS/VHSC/8 mm VCR

- *Tape Start*
- *Tape Load*
- *Tape End*
- *Reel Rotation*
- *Cassette Loading*

Copiers

- *Detect Paper Presence*
- *Toner Density Control*
- *Paper Carrier Detection*
- *Drum Position Detector*
- *Cassette Size Detection*

Standard Reflective Optoswitches

"Arrow" Retro Sensor Reflective Optoswitches

Features

- *Sealed case — no dust collection in holes or seams*
- *Built-in infrared transmitting filter*
- *High Sensitivity*
- *Low cost module*
- *Printed circuit board mount or flying leads*
- *Wide sensing range (0-8 mm object to sensor)*
- *Small size (stackable)*
- *Slotted flange for single mounting screw*

Product Description

This series of reflective optical switches combines an infrared emitting diode (IRED) with an NPN phototransistor or photodarlington in a one piece, sealed, IR transmitting plastic case. Sealed construction improves resistance to moisture and debris. Units are available with PC board mounting leads (VTR16D1 and VTR16E1), or 12 inch, #26 AWG flying leads (VTR17D1 and VTR17E1).

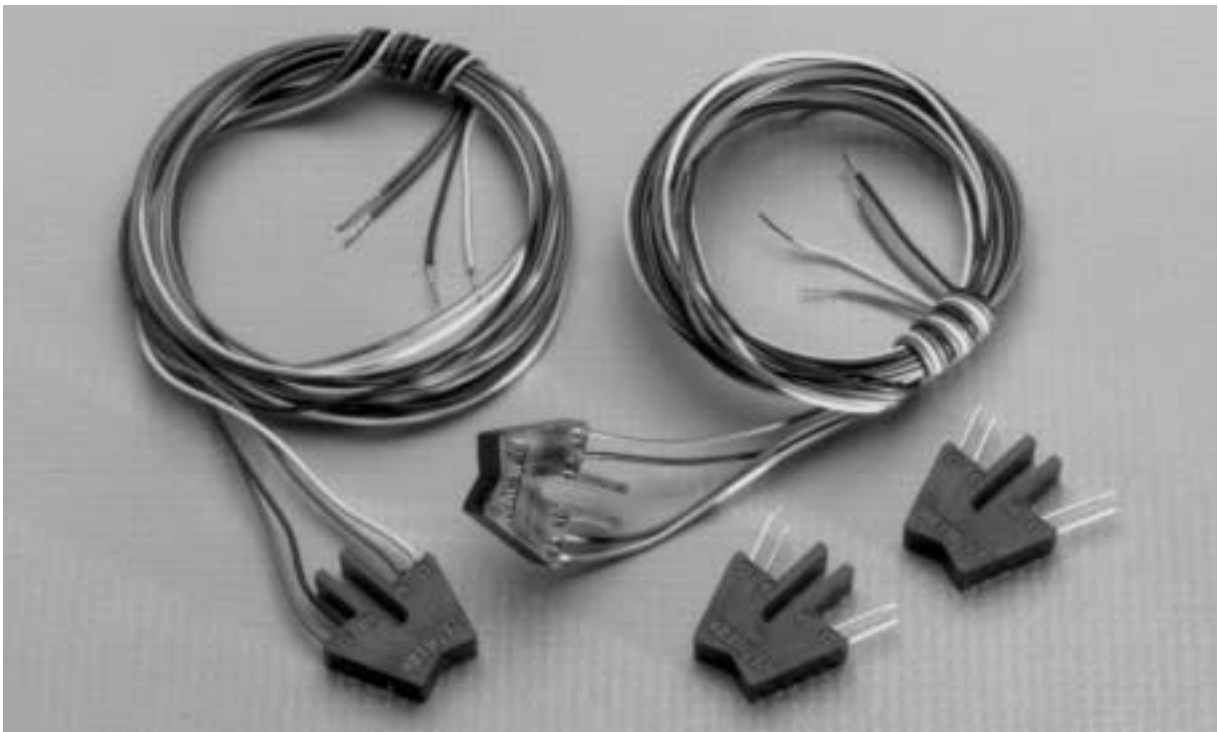

Standard Reflective Optoswitches

Notes On Using Reflective Switches

In its most basic form, a reflective optical switch (retro) consists of a housing which holds both a light source and a detector. Light from the lamp or LED radiates outward and is reflected back should an object be placed in front of the switch. The reflected light is sensed by the photodetector whose output signal changes accordingly.

There are a number of different types of reflective sensors. Designs vary depending upon the application. All have certain characteristics in common. How well they detect an object depends on:

1. Amount of light emitted by the light source.
2. Sensitivity of the photodetector.
3. Distance between the switch and the object being sensed.
4. The light reflecting properties of the object.
5. Ambient lighting conditions.
6. The perpendicularity of the reflective surface to the switch.

When the object to be sensed has a polished surface, such as aluminum foil or mylar tape, often the best type of reflective switch to use is one which is designed to take advantage of the large amount of directly reflected light. This is done by mounting the emitter and detector such that their optical centers lie along the legs of an isosceles triangle such that the angle of the incidence of the emitter is equal to the angle of reflection.

When trying to sense matte objects (which do not have a highly polished surface, such as white paper), it is often possible to use a type of reflective switch optimized for sensing diffuse reflected light. Such devices have the emitter and detector mounted parallel to each other within the switch housing.

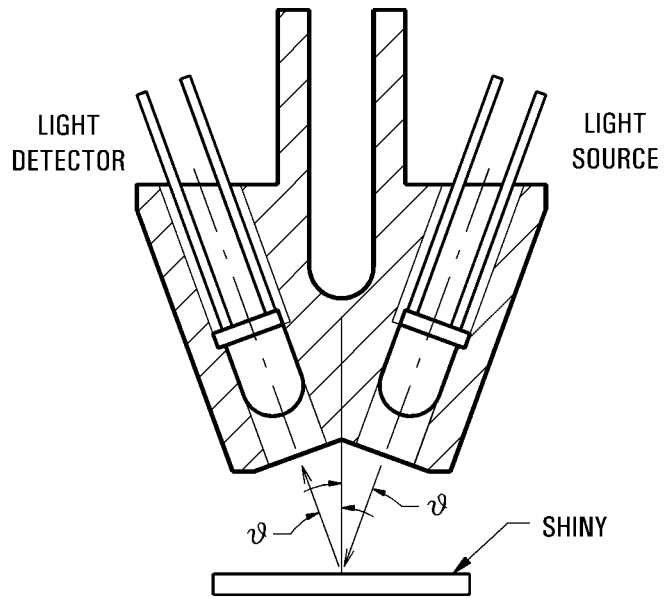

Sensor Used with a Specular Reflectance Surface.

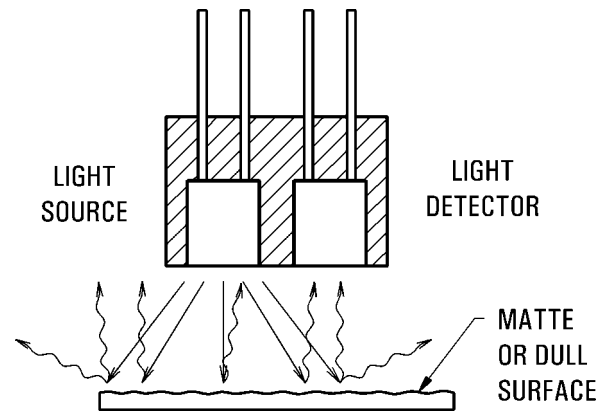

Sensor Used with a Diffuse Reflectance Surface.

Since triangulation is not necessary, the emitter and detector elements can be located very close to each other. This allows for a much smaller package than is usually possible for retros designed to sense specularly reflected light. A retro designed to sense diffused reflected light can be the answer when space is at a premium.

Standard Reflective Optoswitches

Typical Performance Curves For VTR16 & VTR17 Arrow Retros

Output Current vs. Position

(Refer To Test Method No. 2 Below)

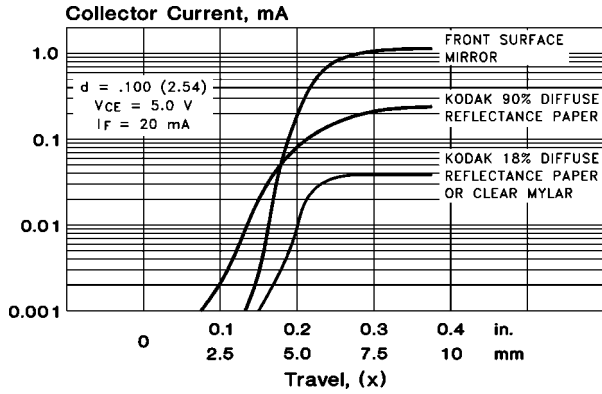

Output Current vs. Position

(Refer To Test Method No. 3 Below)

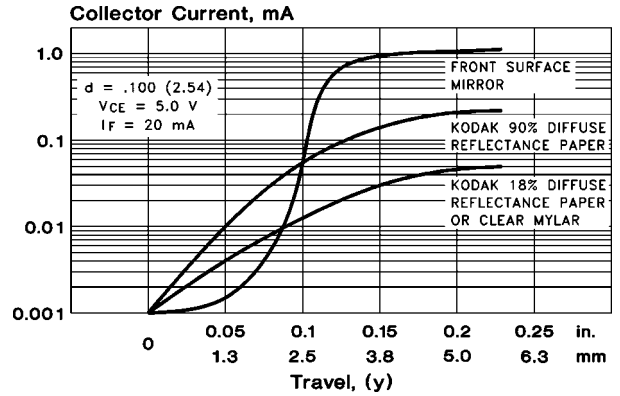

LED Forward Voltage Drop

Forward Current, mA

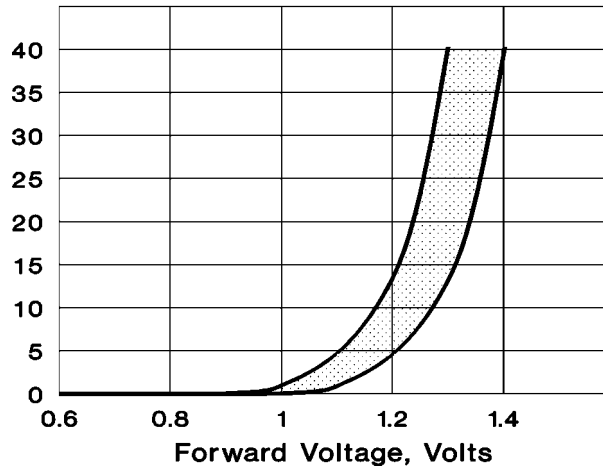

Test Method No. 1

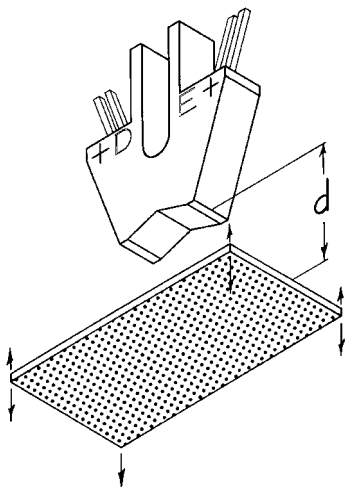

Test Method No. 2

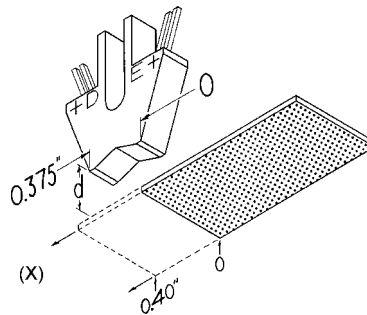

Test Method No. 3

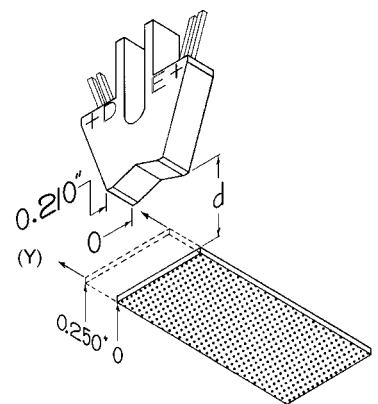

Standard Reflective Optoswitches

Typical Performance Curves (cont.)

LED/Phototransistor Sensors

Output vs. Input Current

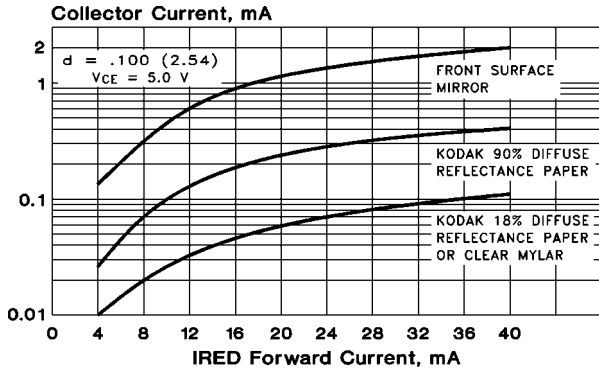

LED/Photodarlington Sensors

Output vs. Input Current

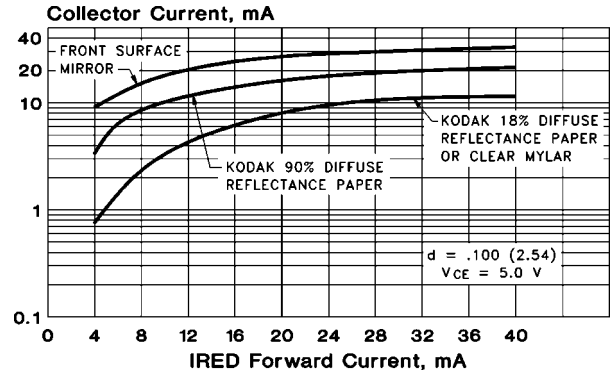

Output Current vs. Distance

(Refer To Test Method No. 1, Page 20)

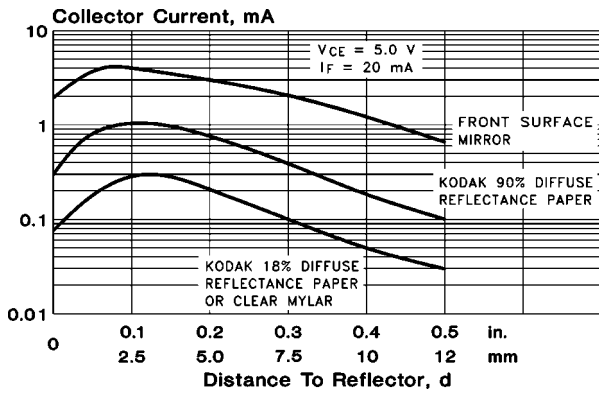

Output Current vs. Distance

(Refer To Test Method No. 1, Page 20)

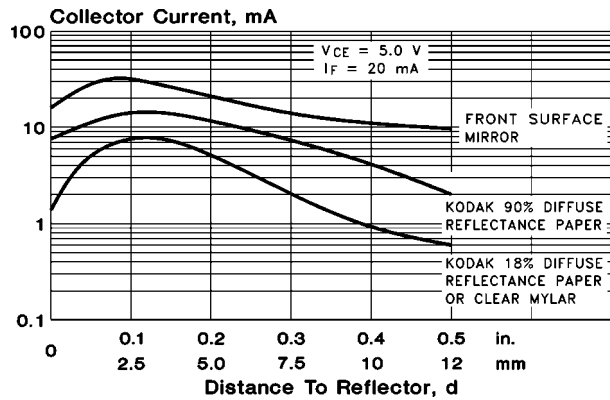

Standard Reflective Optoswitches

Typical Performance Curves (cont.)

LED/Phototransistor Sensors

Relative Output vs. Temperature

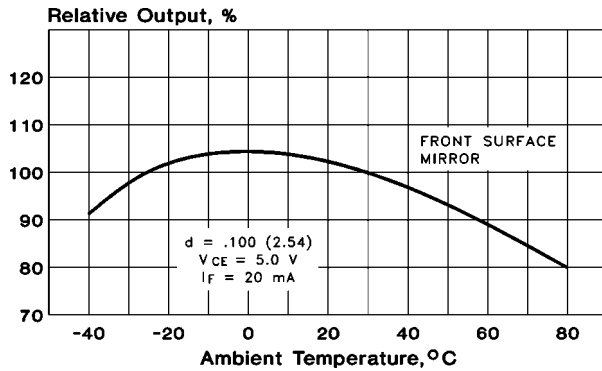

Response Time vs. Load Resistance

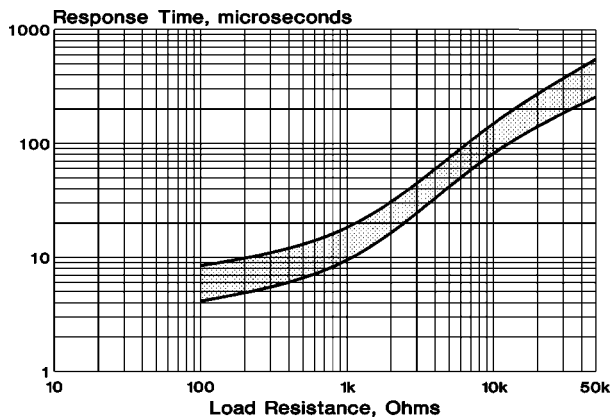

LED/Photodarlington Sensors

Relative Output vs. Temperature

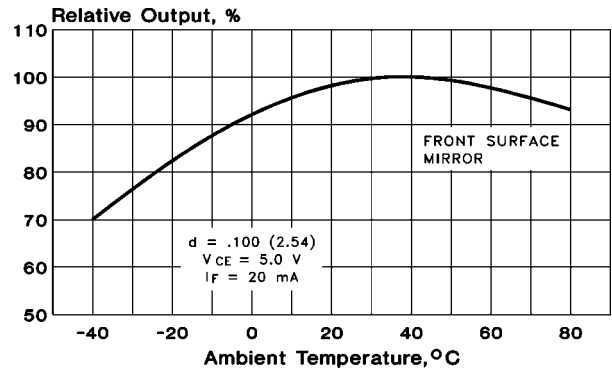

Response Time vs. Load Resistance

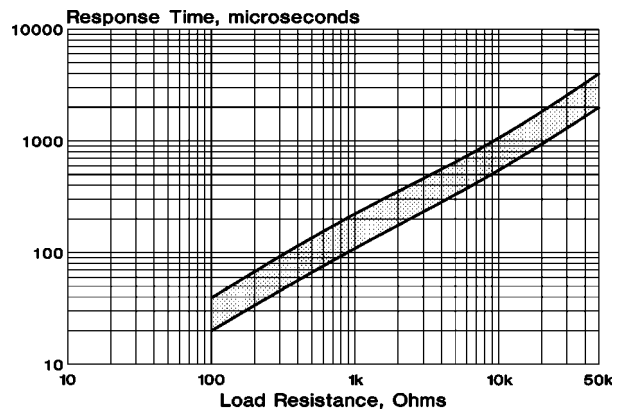

Reflective Optoswitch

Arrow Retro with PCB Mount Leads

VTR16D1

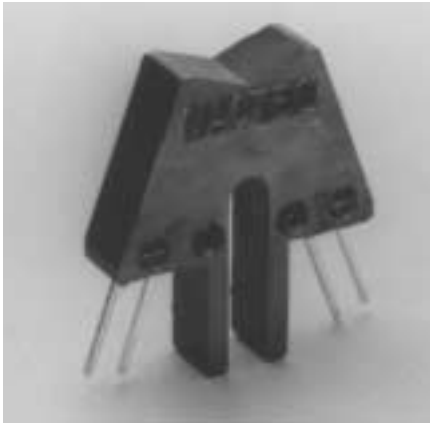

PRODUCT DESCRIPTION

This series of reflective optical switches combines an infrared emitting diode (IRED) with an NPN phototransistor (VTR16D1) in a one piece, sealed, IR transmitting plastic case. The sealed construction improves resistance to moisture and debris. Units have PC board mount leads. Refer to VTR17xx for devices with flying leads.

ABSOLUTE MAXIMUM RATINGS

Maximum Temperatures

Storage and Operating:

-40°C to 85°C

Lead Soldering Temperature:

260°C (1.6 mm from case, 5 seconds max.)

GENERAL CHARACTERISTICS (@ 25°C unless otherwise noted)

Parameter	Symbol	Text Conditions	Input IRED	Output Detector
Reverse Voltage	V_R	$I_R = 100 \mu A$	2.0V Min.	
Continuous Forward Current	I_F	Derate 0.73 mA/°C above 30°C	40 mA Max.	
Forward Voltage Drop	V_F	$I_F = 20 \text{ mA}$	1.8V Max.	
Collector Breakdown Voltage	$V_{BR(CEO)}$	$I_C = 100 \mu A$		30V Min.
Emitter Breakdown Voltage	$V_{BR(ECO)}$	$I_E = 100 \mu A$		5.0V Min.
Power Dissipation	P_D	Derate 0.91 mW/°C above 30°C		50 mW Max.

PACKAGE DIMENSIONS inch (mm)

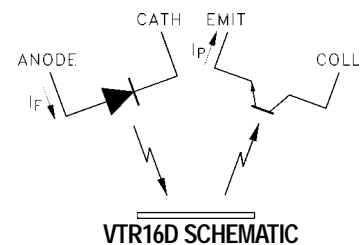
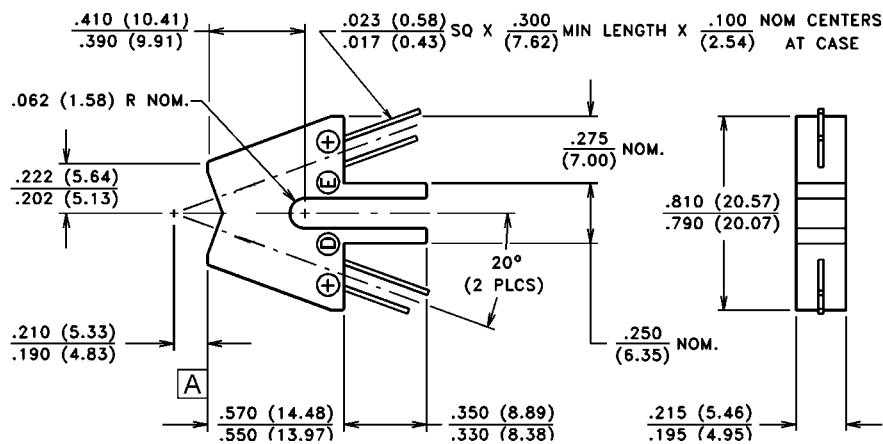

ELECTRO-OPTICAL CHARACTERISTICS @ 25°C (See also curves, pages 19-21)

PART NO. (1) (5)	LIGHT CURRENT, I_p ⁽²⁾				DARK CURRENT ^{(3) (4)}			OUTPUT ELEMENT DETECTOR DEVICE
	mA Min.	Test Conditions			μ A Max.	Test Conditions		
		I_F mA	V_{CE} Volts	d inches (mm)		I_F mA	V_{CE} Volts	
VTR16D1	0.3	20	5	0.10 (2.5)	0.1	0	5	Phototransistor

Notes:

1. The case material is polysulfone and should be cleaned with alcohol or freon TF only. Avoid chlorinated hydrocarbons and solvents such as acetone or toluene, as damage may result.
2. The light current is measured using a 90% reflective surface at the specified distance from Ref. A (refer to Package Dimension Outline on previous page).
3. The dark current is measured with the part totally shielded from ambient light. With 2150 lux (200 fc) from a cool white fluorescent lamp perpendicular to the sensing axis, the detector current will be typically 3 μ A for VTR16D1. The same illumination concentric to the sensing axis will result in a detector current of 50 μ A for VTR16D1. Equivalent light from an incandescent lamp will result in significantly greater currents.
4. With the specified IRED forward current and no reflecting surface, the crosstalk is typically less than 3 μ A for VTR16D1.
5. VTR16D1 accommodates most applications.

Reflective Optoswitch

Arrow Retro with Flying Leads

VTR17D1



PRODUCT DESCRIPTION

This series of reflective optical switches combines an infrared emitting diode (IRED) with an NPN phototransistor (VTR17D1) in a one piece, sealed, IR transmitting plastic case. The sealed construction improves resistance to moisture and debris. Units have 12", #26 AWG leads. Refer to VTR16xx for devices with PC. board mounting leads.

ABSOLUTE MAXIMUM RATINGS

Maximum Temperatures

Storage and Operating: -40°C to 85°C

Operating Temperature: -40°C to 85°C

GENERAL CHARACTERISTICS (@ 25°C unless otherwise noted)

Parameter	Symbol	Text Conditions	Input IRED	Output Detector
Reverse Voltage	V_R	$I_R = 100 \mu A$	2.0V Min.	
Continuous Forward Current	I_F	Derate 0.73 mA/°C above 30°C	40 mA Max.	
Forward Voltage Drop	V_F	$I_F = 20 \text{ mA}$	1.8V Max.	
Collector Breakdown Voltage	$V_{BR(CEO)}$	$I_C = 100 \mu A$		30V Min.
Emitter Breakdown Voltage	$V_{BR(ECO)}$	$I_E = 100 \mu A$		5.0V Min.
Power Dissipation	P_D	Derate 0.91 mW/°C above 30°C		50 mW Max.

PACKAGE DIMENSIONS inch (mm)

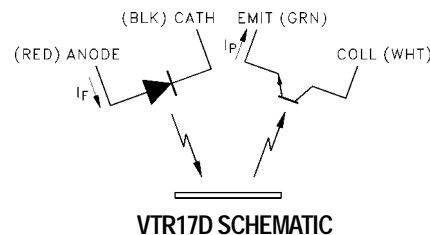
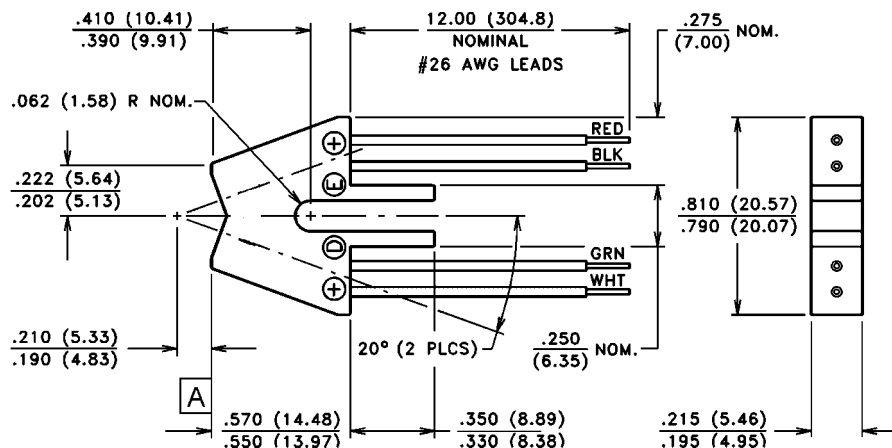

ELECTRO-OPTICAL CHARACTERISTICS @ 25°C (See also curves, pages 19-21)

PART NO. (1) (5)	LIGHT CURRENT, I_p (2)				DARK CURRENT (3) (4)			OUTPUT ELEMENT DETECTOR DEVICE
	mA Min.	Test Conditions			μ A Max.	Test Conditions		
		I_F mA	V_{CE} Volts	d inches (mm)		I_F mA	V_{CE} Volts	
VTR17D1	0.3	20	5	0.10 (2.5)	0.1	0	5	PHOTOTRANSISTOR

Notes:

1. The case material is polysulfone and should be cleaned with alcohol or freon TF only. Avoid chlorinated hydrocarbons and solvents such as acetone or toluene, as damage may result.
2. The light current is measured using a 90% reflective surface at the specified distance from Ref. A (refer to Package Dimension Outline on previous page).
3. The dark current is measured with the part totally shielded from ambient light. With 2150 lux (200 fc) from a cool white fluorescent lamp perpendicular to the sensing axis, the detector current will be typically 3 μ A for VTR17D1. The same illumination concentric to the sensing axis will result in a detector current of 50 μ A for VTR17D1. Equivalent light from an incandescent lamp will result in significantly greater currents.
4. With the specified IRED forward current and no reflecting surface, the crosstalk is typically less than 3 μ A for VTR17D1.
5. VTR17D1 accommodates most applications.

Long Range Retro-reflective Sensor

VTR24F1

PRODUCT DESCRIPTION

This retro-reflective sensor combines an infrared emitting diode and a unique photodarlington output to provide high sensitivity while rejecting ambient light. It has a very long sensing range (up to 4 inches) compared to ordinary retros.

The output of this sensor is activated when a reflective surface is brought into its field of view.

The sensor housing is molded polycarbonate with a slotted flange for easy mounting.

FEATURES

- *Low Cost*
- *Small Package Size*
- *Long Sensing Range (up to 4 inches)*
- *Detects Low/Diffuse Reflectance Surfaces*

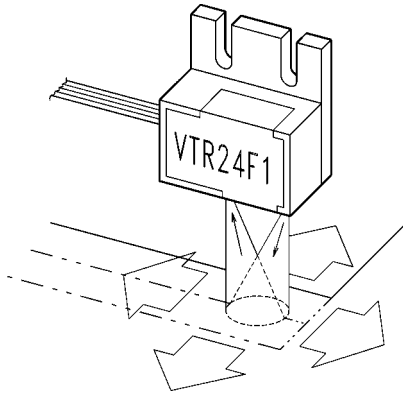

SPECIFICATIONS @ 25°C

Parameter	Symbol	Min.	Typ.	Max.	Units
Output Current $I_F = 20 \text{ mA}^{(5)}$	I_P	6	15		mA
Ambient Sensitivity $I_F = 0 \text{ mA}^{(1)(2)}$	I_A		30	100	μA
Crosstalk $I_F = 20 \text{ mA}^{(3)}$	I_{CX}		5	30	μA
Output Saturation Voltage $I_F = 20 \text{ mA}^{(1)} \quad I_P = 10 \text{ mA}$	V_{SAT}		0.9	1.2	V

NOTES

1. Distance to 90% reflectance paper = 0.6", $V_{CE} = 5\text{V}$.
2. 100 fc fluorescent light incident upon target surface.
3. No target surface.
4. Referenced to optical centerline of sensor, $V_{CE} = 5\text{V}$, $I_F = 20 \text{ mA}$.
5. Distance to 90% reflectance paper = 2.0", $V_{CE} = 5\text{V}$.

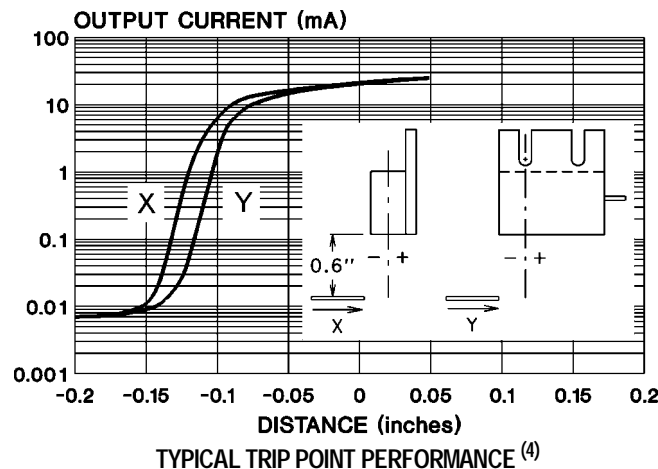

ABSOLUTE MAXIMUM RATINGS @ 25°C UNLESS NOTED

Parameter	Symbol	Rating	Units
Temperature Range			
Operating	T_A	-40 to +85	°C
Storage	T_S	-40 to +85	°C
Continuous Emitter Current	I_F	40	mA
Output Power Dissipation (derate 1.36 mW/°C above 30°C)			
IR Emitter	$P_{D \text{ EMITTER}}$	75	mW
IR Detector	$P_{D \text{ DETECTOR}}$	75	mW
Emitter Reverse Voltage	V_R	2.0	V
Detector Voltage	V_{CE}	30	V

TYPICAL PERFORMANCE CURVES @ 25°C

Output Current vs. Sensing Distance

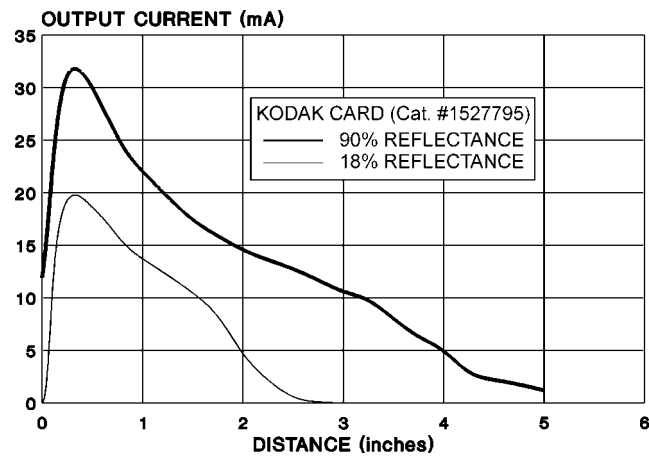

PACKAGE DIMENSIONS inches (mm)

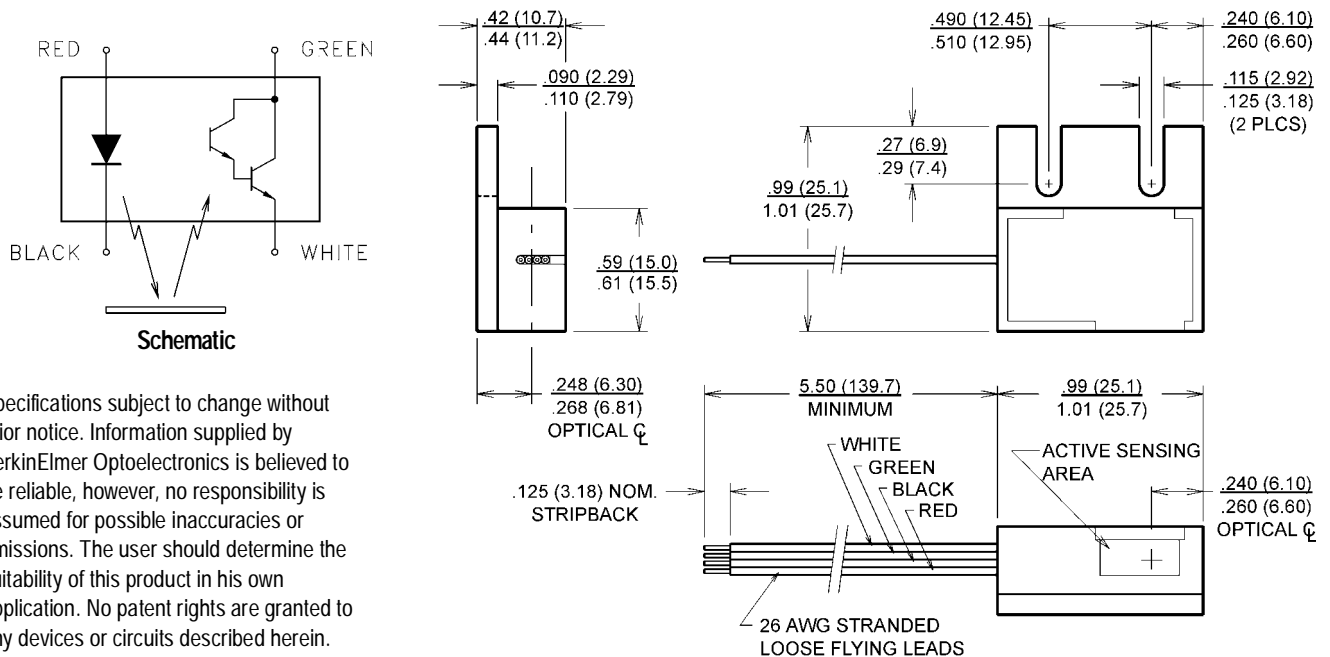

Specifications subject to change without prior notice. Information supplied by PerkinElmer Optoelectronics is believed to be reliable, however, no responsibility is assumed for possible inaccuracies or omissions. The user should determine the suitability of this product in his own application. No patent rights are granted to any devices or circuits described herein.

Standard Transmissive Optoswitches

Slotted Switch Transmissive Optoswitches

Features

- *0.125" (3.18 mm) slot*
- *Phototransistor output*
- *Industry standard PC Board mount or flying leads*
- *TTL compatible*
- *.005, .010, or .020 inch apertures (VTL11D & VTL13D)*
- *.010, .020, or .040 inch apertures (VTL23D)*

Product Description

This series of interrupter type optical switches combines an infrared emitting diode (IRED) with an NPN phototransistor. Units are available in two different case styles, with a one piece, sealed, IR transmitting plastic case (VTL11 and VTL13 series), or an opaque case (VTL23 series). Options also include apertures over detector and/or emitter, and either PC board mount leads or 12 inch, #26 AWG leads (VTL13 only).

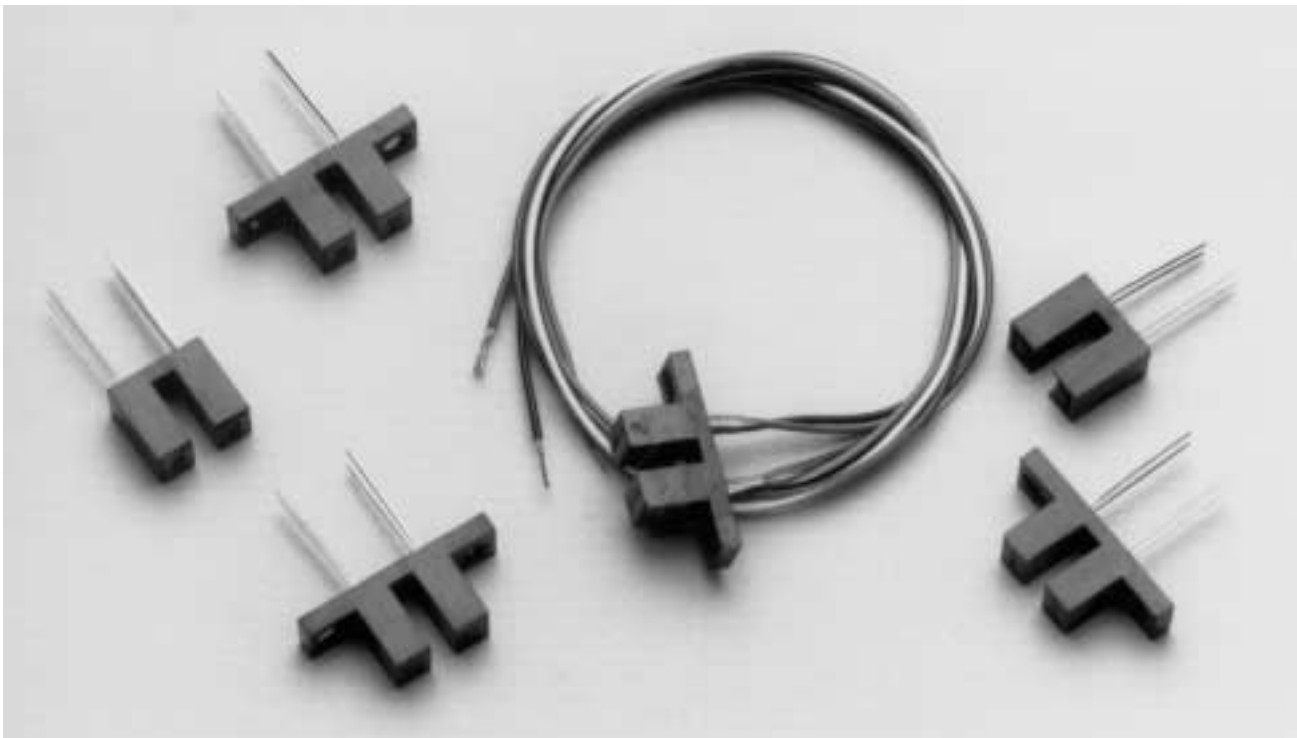

Standard Transmissive Optoswitches

Notes On Using Slotted Switches

Effects of External Light

An IR transmitting plastic is used for the housing, providing a sealed and seamless surface in the light path. Only visible light is absorbed by the housing. Radiation with wavelengths longer than 750 nm is transmitted. Fluorescent lamps primarily produce visible light and the case provides adequate shielding for this source of stray light. However, incandescent or sunlight contains significant amounts of long wavelength light and will cause a substantial increase in collector current. For these environments, the interrupting vane should be designed to block light from the IRED, as well as shield the detector from external stray light sources. In extreme cases, the slotted photoswitch may have to be mounted in a light shielding enclosure.

Effects of Apertures on Position Resolution

Apertures can be installed inside the case to sense vane position with higher resolution. Naturally, apertures also reduce output current signal levels. The adjacent curves show how collector current varies as a thin vane is inserted into the center of the slot of these optoswitches with no aperture, with various apertures on the detector side only, and with apertures on both emitter and detector sides.

When the vane is passed very close to the detector side, some improvement in sharpness of change in collector current is made. If the vane is close to the emitter side, performance is degraded. The major improvement in position sensitivity, $\Delta\%/\Delta d$, is obtained with apertures on both emitter and detector sides, but at the expense of decreased output signal. Position sensing resolution is only slightly increased as the aperture width is directly reduced. With very small apertures on both emitter and detector, stray light may become a significant portion of the signal. Stray light may originate from external sources or from light piping through the plastic housing. The major improvement in performance is obtained with an .020 inch aperture on the emitter side. Additional marginal improvements are obtained by adding smaller apertures on the detector side. When apertures are used on both the emitter and detector sides, performance variations as the interrupting vane or wheel wobbles from side-to-side in the slot are minimized.

Response Time

Response time is determined by the output device. The more sensitive switches have higher sensitivity transistors which have slower response as is shown in the response time graphs. The response is much slower with high value load resistors. To provide a suitable low resistance termination for fastest response, use an external NPN transistor for current gain. Quoted response time curves are for non-saturated switching.

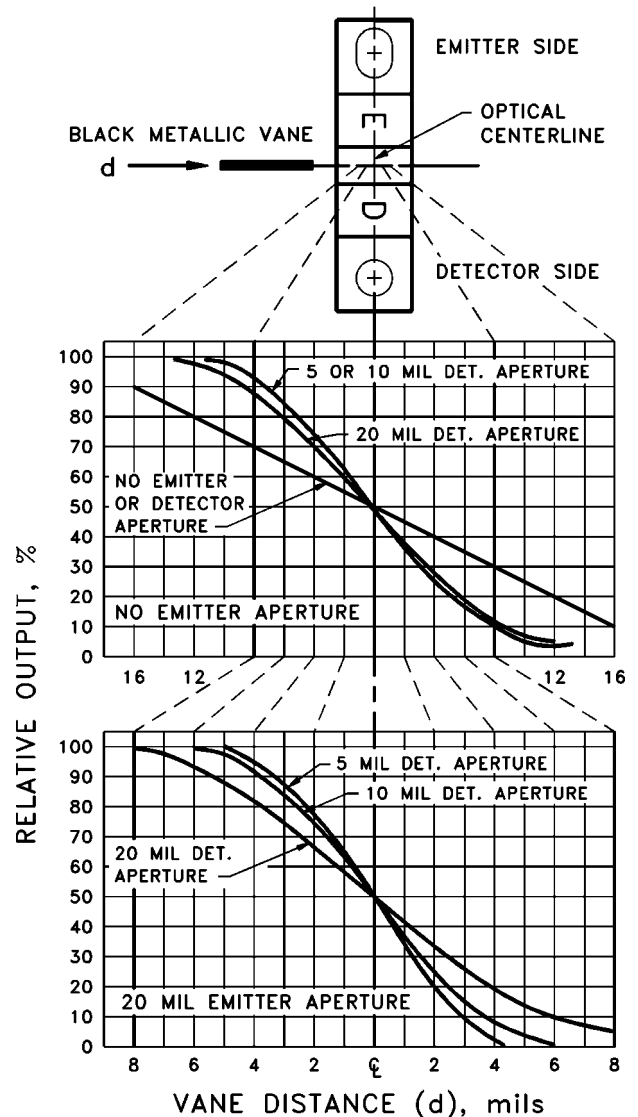

Standard Transmissive Optoswitches

Typical Performance Curves

LED Forward Voltage Drop

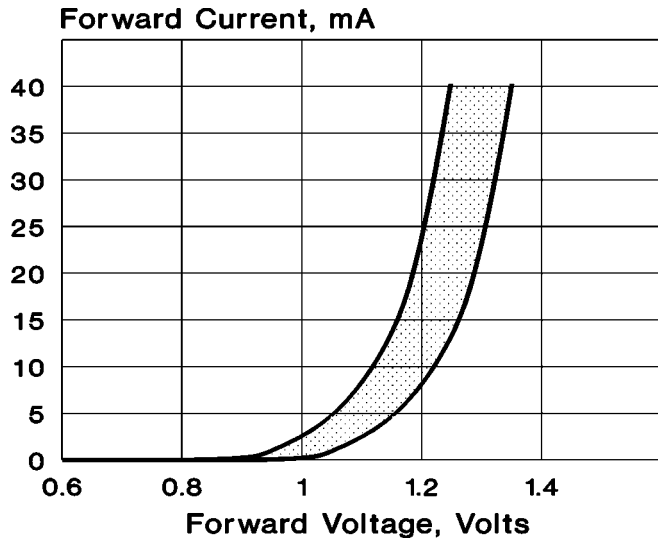

Dark Current vs. Temperature

(Referred TO 25°C)

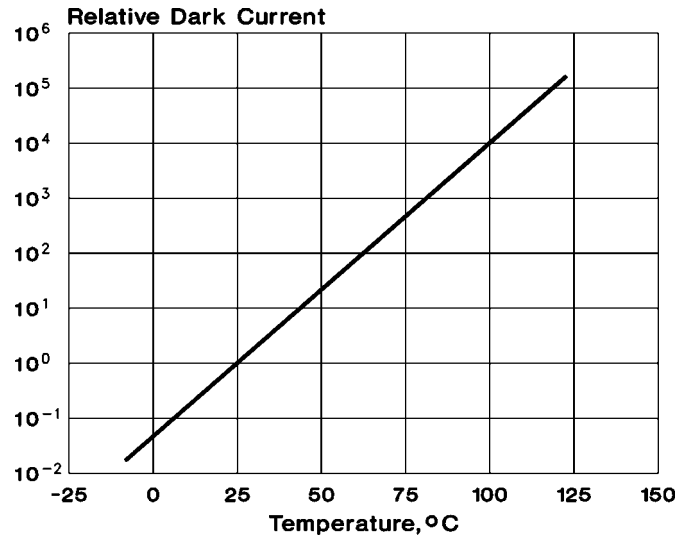

Relative Output vs. Input Current

(Referred TO 20 mA Input Current)

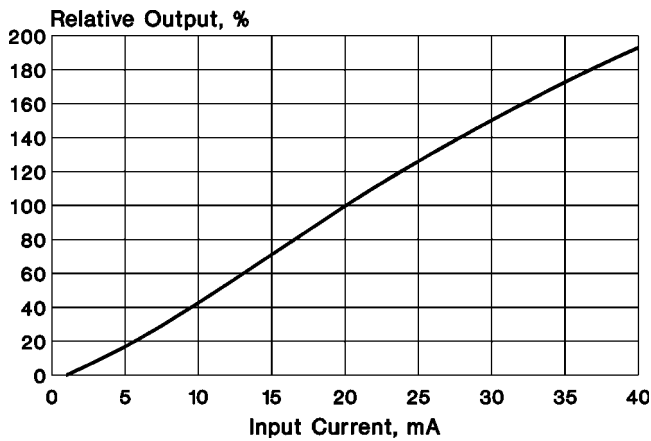

Output Current vs. Temperature

(Referred TO 25°C)

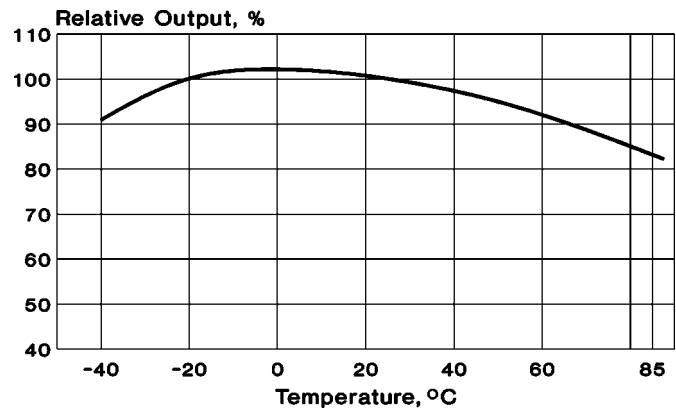

Standard Transmissive Optoswitches

Typical Performance Curves (cont.)

Response Time vs. Load Resistance

(VTL11D & VTL13D)

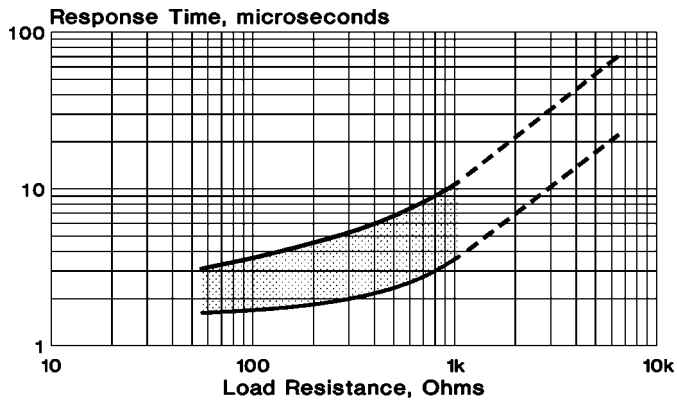

Response Time vs. Load Resistance

(VTL23D)

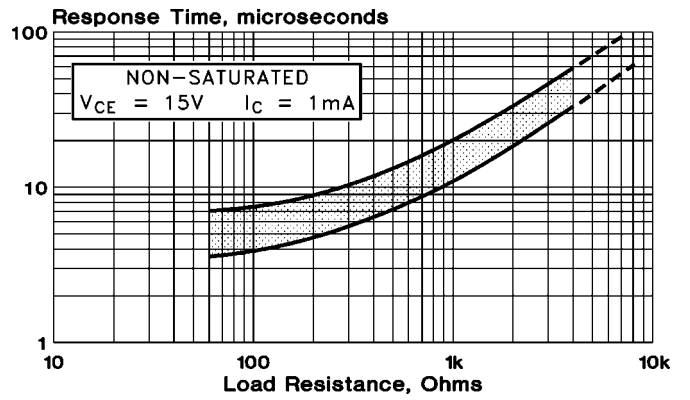

Transmissive Optoswitch

Slotted Switch — 0.395 High

VTL11D1 - D7



PRODUCT DESCRIPTION

This series of interrupter type transmissive optoswitches combines an infrared emitting diode (IRED) with an NPN phototransistor in a one piece, sealed, IR transmitting plastic case. The sealed construction improves resistance to debris and moisture. Internal apertures over detector and/or emitter are available to increase position sensing resolution. These devices are furnished with PC board mount leads. Refer to VTL13 for devices with flying leads.

ABSOLUTE MAXIMUM RATINGS

Maximum Temperatures

Storage and Operating:

-40°C to 85°C

Lead Soldering Temperature:

260°C (1.6 mm from case, 5 seconds max.)

GENERAL CHARACTERISTICS (@ 25°C unless otherwise noted)

Parameter	Symbol	Text Conditions	Input IRED	Output Detector
Reverse Voltage	V_R	$I_R = 100 \mu A$	2.0V Min.	
Continuous Forward Current	I_F	Derate 0.73 mA/°C above 30°C	40 mA Max.	
Forward Voltage Drop	V_F	$I_F = 20 \text{ mA}$	1.8V Max.	
Collector Breakdown Voltage	$V_{BR(CEO)}$	$I_C = 100 \mu A$		30V Min.
Emitter Breakdown Voltage	$V_{BR(ECO)}$	$I_C = 100 \mu A$		5.0V Min.
Power Dissipation	P_D	Derate 0.91 mW/°C above 30°C		50 mW Max.

PACKAGE DIMENSIONS inch (mm)

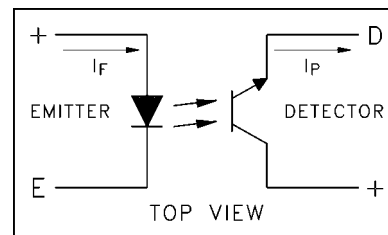
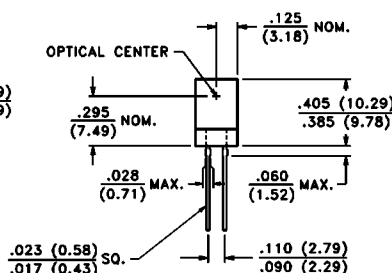
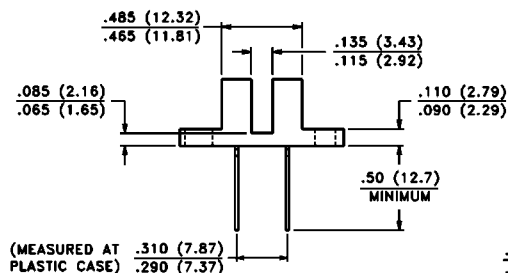
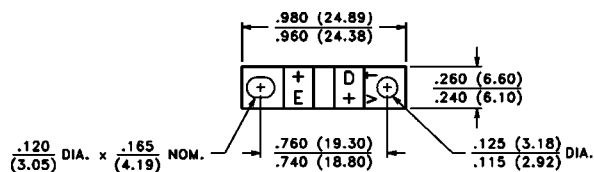

ELECTRO-OPTICAL CHARACTERISTICS @ 25°C (See also curves, pages 30 & 31)

PART NO. (4)	LIGHT CURRENT, I_p			DARK CURRENT ⁽¹⁾			SATURATION VOLTAGE			APERTURE COMBINATION ⁽²⁾	
	mA Min.	Test Conditions		nA Max.	Test Conditions		Volts Max.	Test Conditions		Emitter	Detector
		I_F mA	V_{CE} Volts		I_F mA	V_{CE} Volts		I_F mA	I_C mA		
VTL11D1	0.5	20	5	100	0	10	0.4	20	0.25	None	None
VTL11D1-20	0.15	20	5	100	0	10	0.4	20	0.25	.020" Wide	None
VTL11D3	2.0	20	5	100	0	10	0.4	20	1.8	None	None
VTL11D3-20	0.6	20	5	100	0	10	0.4	20	1.8	.020" Wide	None
VTL11D5-20	0.15	20	5	100	0	10	0.4	20	0.25	.020" Wide	.010" Wide
VTL11D6-20	0.075	20	5	100	0	10	0.4	20	0.25	.020" Wide	.005" Wide
VTL11D7	0.75	20	5	100	0	10	0.4	20	0.25	None	.020" Wide
VTL11D7-20	0.225	20	5	100	0	10	0.4	20	0.25	.020" Wide	.020" Wide

Notes:

1. The dark current is measured with the part totally shielded from ambient light. With 2150 lux (200 fc) from a cool white fluorescent lamp falling on the part, the typical dark current will be 3 μ A for VTL11D devices. Equivalent light from an incandescent lamp will result in significantly greater currents.
2. The apertures used for these slotted switches are .040" (1.02 mm) high.
3. The case material is polysulfone and should be cleaned with alcohol or freon TF only. Avoid chlorinated hydrocarbons and solvents such as acetone or toluene, as damage may result.
4. VTL11D7-20 accommodates most applications. The other parts in this series are available only for specialized, high volume applications.

Transmissive Optoswitch

Slotted Switch — 0.395 High

VTL13D1 - D7

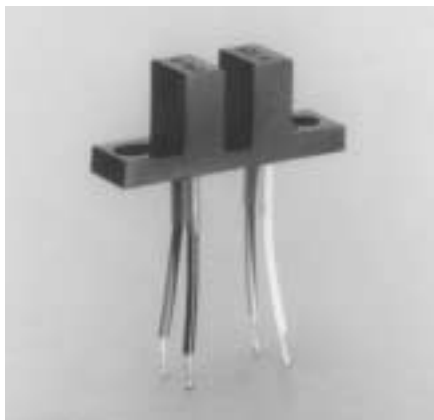

PRODUCT DESCRIPTION

This series of interrupter type transmissive optoswitches combines an infrared emitting diode (IRED) with an NPN phototransistor in a one piece, sealed, IR transmitting plastic case. The sealed construction improves resistance to debris and moisture. Internal apertures over detector and/or emitter are available to increase position sensing resolution. These devices are furnished with 12 inch, #26 AWG leads. Refer to VTL11 for devices with P.C.B. mount leads.

ABSOLUTE MAXIMUM RATINGS

Maximum Temperatures

Storage and Operating: -40°C to 85°C

Operating Temperature: -40°C to 85°C

GENERAL CHARACTERISTICS (@ 25°C unless otherwise noted)

Parameter	Symbol	Text Conditions	Input IRED	Output Detector
Reverse Voltage	V_R	$I_R = 100 \mu A$	2.0V Min.	
Continuous Forward Current	I_F	Derate 0.73 mA/°C above 30°C	40 mA Max.	
Forward Voltage Drop	V_F	$I_F = 20 \text{ mA}$	1.8V Max.	
Collector Breakdown Voltage	$V_{BR(CEO)}$	$I_C = 100 \mu A$		30V Min.
Emitter Breakdown Voltage	$V_{BR(ECO)}$	$I_C = 100 \mu A$		5.0V Min.
Power Dissipation	P_D	Derate 0.91 mW/°C above 30°C		50 mW Max.

PACKAGE DIMENSIONS inch (mm)

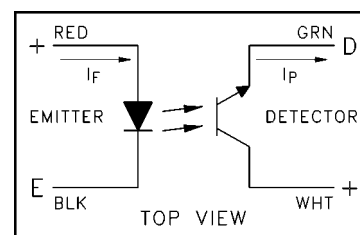
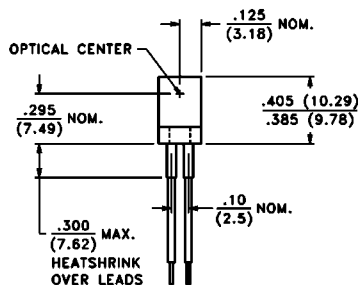
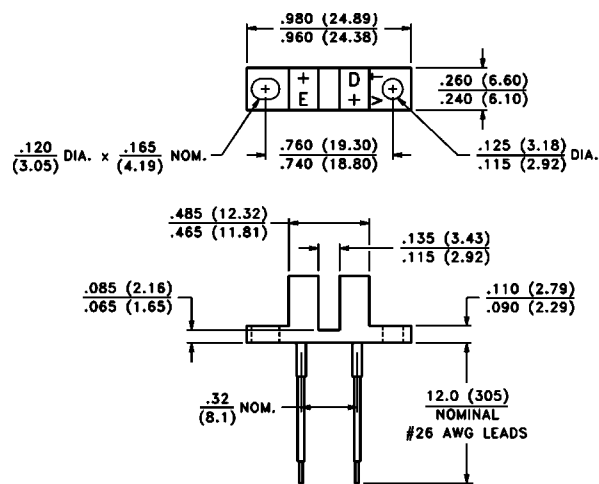

ELECTRO-OPTICAL CHARACTERISTICS @ 25°C (See also curves, pages 30 & 31)

PART NO. (4)	LIGHT CURRENT, I _p			DARK CURRENT ⁽¹⁾			SATURATION VOLTAGE			APERTURE COMBINATION ⁽²⁾	
	mA Min.	Test Conditions		nA Max.	Test Conditions		Volts Max.	Test Conditions		Emitter	Detector
		I _F mA	V _{CE} Volts		I _F mA	V _{CE} Volts		I _F mA	I _C mA		
VTL13D1	0.5	20	5	100	0	10	0.4	20	0.25	None	None
VTL13D1-20	0.15	20	5	100	0	10	0.4	20	0.25	.020" Wide	None
VTL13D3	2.0	20	5	100	0	10	0.4	20	1.8	None	None
VTL13D3-20	0.6	20	5	100	0	10	0.4	20	1.8	.020" Wide	None
VTL13D5-20	0.15	20	5	100	0	10	0.4	20	0.25	.020" Wide	.010" Wide
VTL13D6-20	0.075	20	5	100	0	10	0.4	20	0.25	.020" Wide	.005" Wide
VTL13D7	0.75	20	5	100	0	10	0.4	20	0.25	None	.020" Wide
VTL13D7-20	0.225	20	5	100	0	10	0.4	20	0.25	.020" Wide	.020" Wide

Notes:

1. The dark current is measured with the part totally shielded from ambient light. With 2150 lux (200 fc) from a cool white fluorescent lamp falling on the part, the typical dark current will be 3 μ A for VTL13D devices. Equivalent light from an incandescent lamp will result in significantly greater currents.
2. The apertures used for these slotted switches are .040" (1.02 mm) high.
3. The case material is polysulfone and should be cleaned with alcohol or freon TF only. Avoid chlorinated hydrocarbons and solvents such as acetone or toluene, as damage may result.
4. VTL13D7-20 accommodates most applications. The other parts in this series are available only for specialized, high volume applications.

Transmissive Optoswitch

Slotted Switch — 0.425 High

VTL23DxA Series

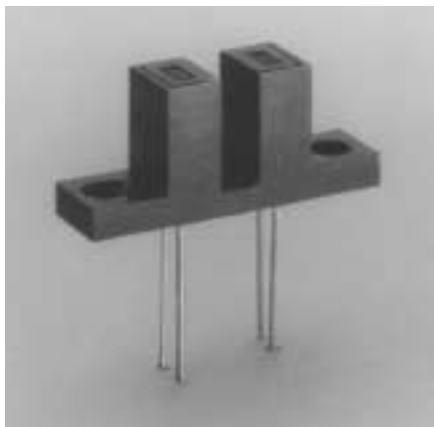

PRODUCT DESCRIPTION

This series of interrupter type transmissive optoswitches combines an infrared emitting diode (IRED) with an NPN phototransistor in an opaque plastic case with two mounting tabs. Visible light blocking dust covers are provided over the .04" (1.0 mm) wide molded-in apertures. Smaller width external aperture covers are available to increase position sensing resolution. These devices are furnished with P.C.board mount leads.

ABSOLUTE MAXIMUM RATINGS

Maximum Temperatures

Storage and Operating:

-40°C to 85°C

Lead Soldering Temperature:

260°C (1.6 mm from case, 5 seconds max.)

GENERAL CHARACTERISTICS (@ 25°C unless otherwise noted)

Parameter	Symbol	Text Conditions	Input IRED	Output Detector
Reverse Voltage	V_R	$I_R = 100 \mu A$	2.0V Min.	
Continuous Forward Current	I_F	Derate 0.73 mA/°C above 30°C	40 mA Max.	
Forward Voltage Drop	V_F	$I_F = 20 \text{ mA}$	1.8V Max.	
Collector Breakdown Voltage	$V_{BR(CEO)}$	$I_C = 100 \mu A$		30V Min.
Emitter Breakdown Voltage	$V_{BR(ECO)}$	$I_C = 100 \mu A$		3.0V Min.
Power Dissipation	P_D	Derate 0.91 mW/°C above 30°C		50 mW Max.

PACKAGE DIMENSIONS inch (mm)

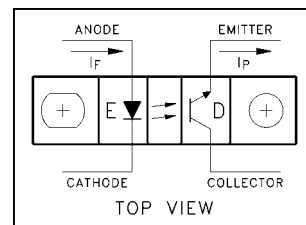
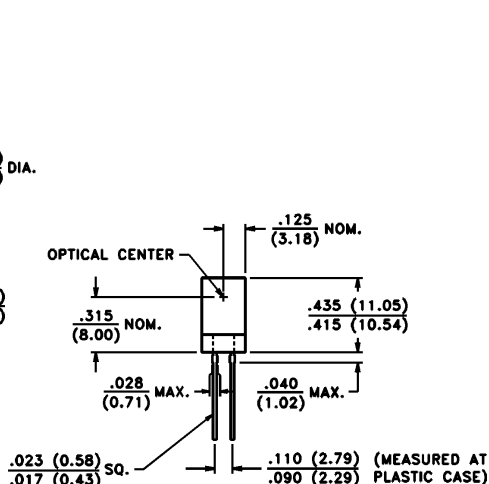
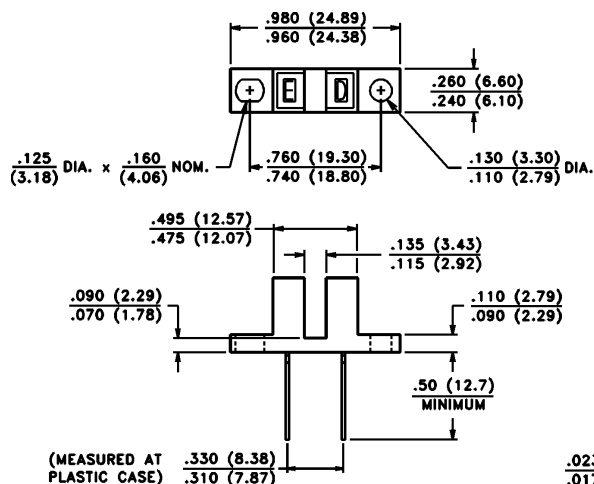

ELECTRO-OPTICAL CHARACTERISTICS @ 25°C (See also curves, pages 30 & 31)

PART NO. (4)	LIGHT CURRENT, I_p			DARK CURRENT ⁽¹⁾			SATURATION VOLTAGE			EMITTER/DETECTOR APERTURE WIDTH (Aperture Length is .075")
	mA Min.	Test Conditions		nA Max.	Test Conditions		Volts Max.	Test Conditions		
		I_F mA	V_{CE} Volts		I_F mA	V_{CE} Volts		I_F mA	I_C mA	
VTL23D0A21	0.2	20	10	100	0	10	0.4	20	0.1	.020" EMIT./010" DET.
VTL23D0A22	0.2	20	10	100	0	10	0.4	20	0.1	.020" EMIT. & DET.
VTL23D1A00	0.5	20	10	100	0	10	0.4	20	0.4	.040" EMIT. & DET.
VTL23D1A22	0.5	20	10	100	0	10	0.4	20	0.4	.020" EMIT. & DET.
VTL23D2A00	2.5	20	10	100	0	10	0.6	20	1.8	.040" EMIT. & DET. ⁽²⁾
VTL23D3A00	1.0	10	10	100	0	10	0.4	10	0.8	.040" EMIT. & DET. ⁽²⁾

Notes:

1. The dark current is measured with the part totally shielded from ambient light.
2. Contains a visible light blocking dust cover over the apertures.
3. The plastic case can be damaged by chlorinated hydrocarbons and ketones. Methanol isopropanol alcohols are recommended as cleaning agents.
4. VTL23D1A22 accommodates most applications. The other parts in this series are available only for specialized, high volume applications.

PerkinElmer Optoelectronics

Warranty Statement

PerkinElmer Optoelectronics warrants that all items sold will be free from defects in materials and workmanship under normal use and service for a period of one year from the date of shipment. If PerkinElmer Optoelectronics receives notice of such defects during the warranty period, PerkinElmer Optoelectronics shall, at its option, repair or replace any defective components or credit the purchaser's account with the purchase price paid. This warranty shall not apply to items that have been (a) subject to misuse, neglect, accident, damage in transit, abuse or unusual hazard; (b) altered, modified or repaired by anyone other than PerkinElmer Optoelectronics; or (c) used in violation of instructions furnished by PerkinElmer Optoelectronics. The Buyer should contact PerkinElmer Optoelectronics for a return authorization number prior to shipping returned parts.

The specific PerkinElmer Optoelectronics' products shown in this catalog are not authorized or recommended for use as critical components in life support systems or in surgical implant devices wherein a failure or malfunction of the PerkinElmer Optoelectronics product may directly threaten life or cause personal injury. The Buyer agrees to notify PerkinElmer Optoelectronics of any such intended application and to proceed only after receiving the expressed written approval of an officer of PerkinElmer Optoelectronics. Additionally, the user of PerkinElmer Optoelectronics components in life support or implant applications assumes all risks of such use and indemnifies PerkinElmer Optoelectronics against all damages.

In order to provide the best possible products, PerkinElmer Optoelectronics reserves the right to change specifications without prior notice. Information supplied in PerkinElmer Optoelectronics' catalogs, data sheets, and other literature, and information supplied by PerkinElmer Optoelectronics' technical support personnel is believed to be reliable, however, PerkinElmer Optoelectronics cannot assume responsibility for omissions, errors, or misapplication of this information.

It is the responsibility of the Buyer to determine the suitability of PerkinElmer Optoelectronics/ products and recommendations in his own specific application, particularly when the products are operated at or near their maximum rating specifications. No license is granted by implication or otherwise of any patent, copyright, or trademark right of PerkinElmer Optoelectronics or others.

PerkinElmer Optoelectronics' warranty, as stated above, shall not be affected or changed by, and no obligation or liability shall grow out of, PerkinElmer Optoelectronics' providing technical advice or service to the Buyer.

PERKINELMER OPTOELECTRONICS MAKES NO OTHER WARRANTIES, EXPRESSED OR IMPLIED, AND EXPRESSLY EXCLUDES AND DISCLAIMS ANY WARRANTIES OF MERCHANTABILITY OR FITNESS FOR A PARTICULAR PURPOSE. THE REMEDIES PROVIDED HEREIN ARE THE BUYER'S SOLE EXCLUSIVE REMEDIES. PERKINELMER OPTOELECTRONICS SHALL NOT BE LIABLE FOR ANY INDIRECT, SPECIAL, INCIDENTAL, OR CONSEQUENTIAL DAMAGES, WHETHER BASED ON CONTRACT, TORT, OR ANY LEGAL THEORY. PERKINELMER OPTOELECTRONICS' LIABILITY ON ANY CLAIM SHALL IN NO CASE EXCEED THE PRICE ALLOCABLE TO THE ITEM WHICH GIVES RISE TO THE CLAIM.

Quality Statement

PerkinElmer Optoelectronics' business is the design, development, and production of optoelectronic components and assemblies. Our development and manufacturing activities focus on achieving and maintaining consistent product quality and high levels of reliability. PerkinElmer produces devices and assemblies for the commercial, industrial, automotive, and medical markets.

PerkinElmer's commitment to quality emphasizes designed-in quality, problem prevention, and closed loop corrective action. This concept of quality is implemented through the use of fully documented procedures, in-process monitoring and process control (including SPC), and 100% production testing of devices using state-of-the-art automated test equipment. As a world class manufacturer, PerkinElmer's concept of product quality includes Total Quality Management (TQM) and Just In Time (JIT) delivery.

Quality is a measure of how well a device conforms to its specifications. Reliability is a measure of how well a device performs over time. PerkinElmer insures the reliability of its products by careful design and by the periodic testing of random samples taken from the manufacturing lines. Reliability tests include temperature cycles, thermal shock, room ambient life tests, elevated temperature life tests, high and low temperature storage, temperature/humidity tests, and water immersion.

PerkinElmer also performs special tests covering a wide range of environmental and life stress conditions to support non-standard, custom applications. The information generated not only assures the customer that the device will work well in a particular application, but also contributes to our data base for continual product improvement.

Driven by our goal of continuous improvement and the needs of customers, PerkinElmer runs an active product improvement program. PerkinElmer continuously evaluates new materials, manufacturing processes, and packaging systems in order to provide our customers with the best possible product.

PerkinElmer's quality works: we are an ISO 9000 and QS 9000 certified supplier (ship to stock - no inspection required) to a number of major customers.



Additional Sensor Products Catalogs

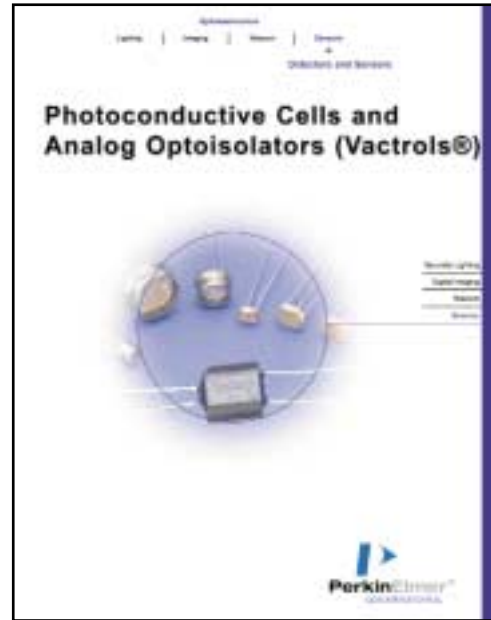
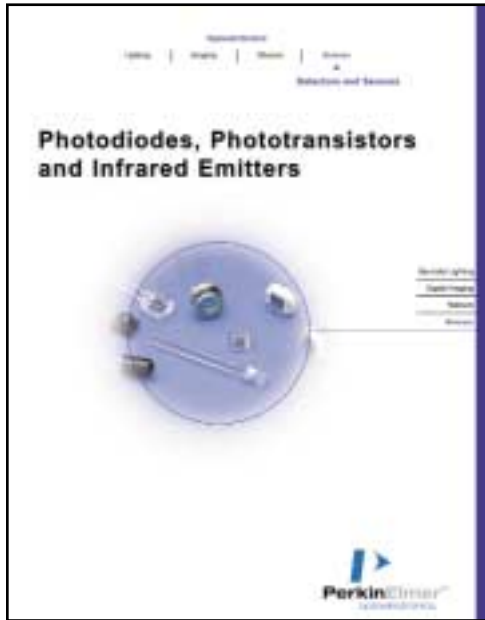

USA:
PerkinElmer Optoelectronics
10900 Page Avenue
St. Louis, MO 63132
Phone: (314) 423-4900
Fax: (314) 423-3956

Europe:
PerkinElmer Optoelectronics
Wenzel-Jaksch-Str. 31
D-65199 Wiesbaden
Germany
Phone: +49 611 492 0
Fax: +49 611 492 170

Asia:
PerkinElmer Optoelectronics
Room 1404, Kodak House II
39 Healthy Street East
North Point, Hong Kong
Phone: 852 2590 0238
Fax: 852 2590 0513

