

# ECE445M/ECE380L.12 Embedded and Real-Time Systems/ Real-Time Operating Systems

## Lecture 9: Networking, CAN bus, Ethernet, Embedded Internet, TCP/IP

Lecture 9

J. Valvano, A. Gerstlauer  
ECE445M/ECE380L.12

1

## Network

- Collection of interfaces that share a physical medium and data protocol
  - Communicate & synchronize tasks across computers
  - Distributed computing

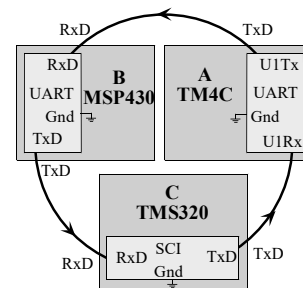
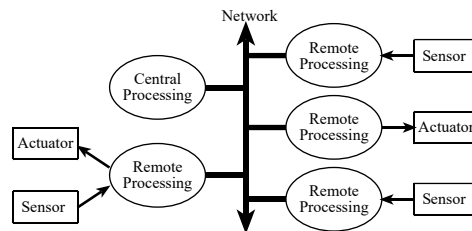

Figure 9.1. A simple ring network with three nodes, linked using the serial ports.

Lecture 9

J. Valvano, A. Gerstlauer  
ECE445M/ECE380L.12

2

# Network Topology

- Ring (previous slide)
- Shared bus
- Star
- Mesh
- ...

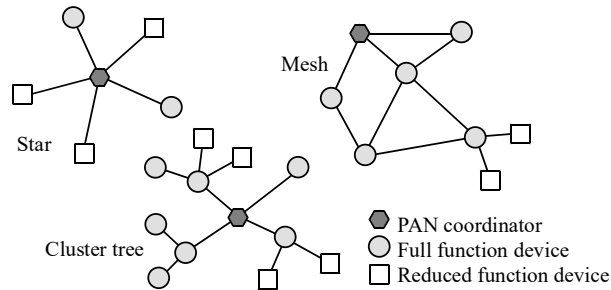

Figure 9.2. ZigBee wireless networks communicate by hopping between nodes.

Lecture 9

J. Valvano, A. Gerstlauer  
ECE445M/ECE380L.12

3

# Layered Approach

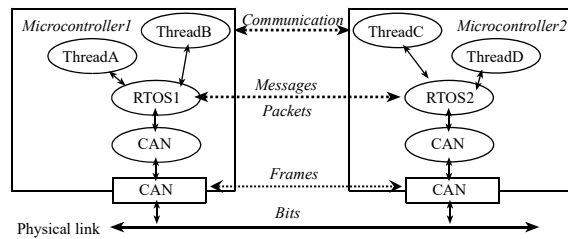

Figure 9.3. A layered approach to communication systems.

- Physical & link layer (bits & frames)
- OS layer (message & packets)
- Application layer (sessions)

Lecture 9

J. Valvano, A. Gerstlauer  
ECE445M/ECE380L.12

4

## Physical Layer: Bits & Bytes

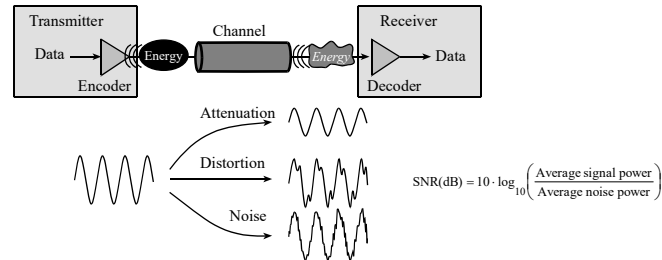

- Shannon channel capacity  

$$C = W \log_2 (1 + \text{SNR}) \text{ b/s}$$
- Example: Telephone channel  
 $W = 3.4\text{kHz}$  and  $\text{SNR} \sim 38 \text{ dB} \Rightarrow \text{SNR} \sim 6310$   
 $C = 3.4\text{kHz} \log_2 (6311) = 3.4\text{kHz} \times 12.62 \text{ b/s} = \underline{42.9 \text{ kb/s}}$

Lecture 9

J. Valvano, A. Gerstlauer  
ECE445M/ECE380L.12

5

## Link Layer: Framing & Messaging



Figure 9.19. An Ethernet frame can hold 46 to 1500 bytes.

1. Address information field
  - Physical address specifying destination/source computer
  - Logical address specifying destination/source processes
2. Synchronization or handshake field
  - Physical synchronization, e.g. shared clock, start/stop bits
  - OS/process synchronization, e.g. request/ack, semaphore
3. Data field
  - ASCII or binary (raw or compressed)
4. Error detection and correction field
  - Parity, checksum, error correcting codes (ECC)

Lecture 9

J. Valvano, A. Gerstlauer  
ECE445M/ECE380L.12

6

# Controller Area Network (CAN)

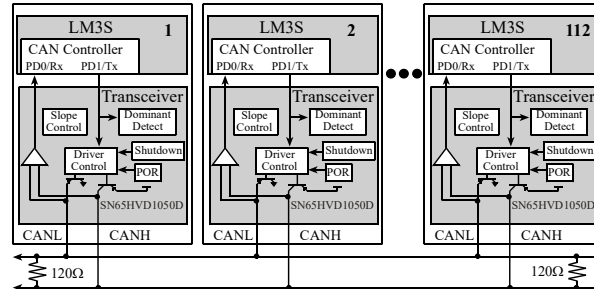

- Originally for use in automobiles (car area network)
- High-integrity serial communications
- Real-time applications
- Up to 1 Mbits/second (@ max. 40m), up to 112 nodes
- Half duplex (both directions, but only one at a time)

Lecture 9

J. Valvano, A. Gerstlauer  
ECE445M/ECE380L.12

7

# CAN Bus

- Shared bus topology
  - Broadcast operation

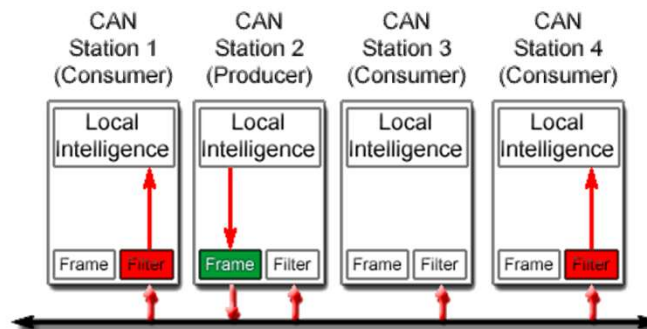

Source: <http://can-cia.org/index.php?id=can>

© 2002, CAN in Automation - TS

Lecture 9

J. Valvano, A. Gerstlauer  
ECE445M/ECE380L.12

8

# CAN Signaling

- **Wired-AND logic**
  - Similar to wired-OR or open collector logic

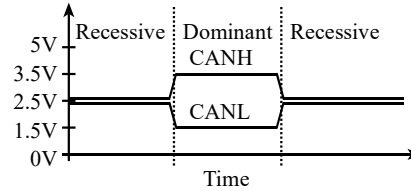

- Dominant state is logic low (0)
- Recessive state is logic high (1)

Lecture 9

J. Valvano, A. Gerstlauer  
ECE445M/ECE380L.12

9

# CAN Protocol

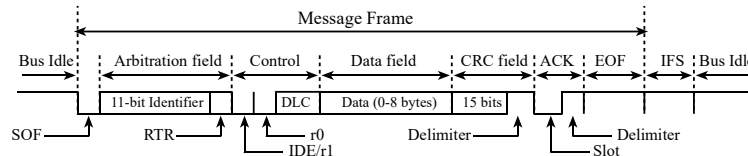

Figure 9.7. CAN Standard Format Data Frame.

- **Data, Remote, Error or Overload frames**
  - **Arbitration Field**
    - 11-bit identifier specifies data type (not address), e.g. Ping, IR, ...
    - RTR=IDE=0 means 11-bit standard format data frame
  - **Control Field**
    - DLC specifies the number of data bytes (0 to 8)
  - **Data Field**
    - Contains zero to eight bytes of data
  - **CRC Field**
    - 15-bit checksum used for error detection

Lecture 9

J. Valvano, A. Gerstlauer  
ECE445M/ECE380L.12

10

## CAN Arbitration

- Bit-wise arbitration
  - Priority handled by dominant win over recessive
    - Lower IDs are higher priority

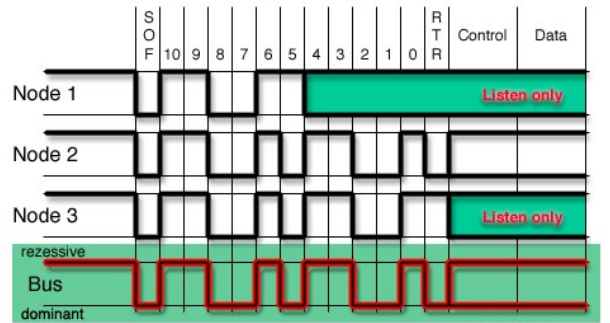

Source: <http://can-cia.org/index.php?id=can>

© 2002. CAN in Automation - TS

Lecture 9

J. Valvano, A. Gerstlauer  
ECE445M/ECE380L.12

11

## CAN Bandwidth

$$\text{Bandwidth} = \frac{\text{number of information bits/frame}}{\text{total number of bits/frame}} \cdot \text{baud rate}$$

- Number of bits in a CAN message frame
  - ID: 11 or 29 bits
    - Standard CAN 2.0A vs. extended CAN 2.0B
  - Data: 0, 8, 16, 24, 32, 40, 48, 56, or 64 bits
  - Remaining components: 36 bits
    - SOF (1)
    - RTR (1)
    - IDE/r1 (1)
    - r0 (1)
    - DLC (4)
    - CRC (15)
    - ACK/EOF/intermission (13)

**How many bits in a frame:**  
Standard CAN 2.0A frame with 4 data bytes?  
Extended CAN 2.0B frame with 8 data bytes?

Lecture 9

J. Valvano, A. Gerstlauer  
ECE445M/ECE380L.12

12

# CAN Synchronization

- Synchronous bit transmission
  - Where is the clock? (Answer: in the data)
  - Needs edges so the receiver can synchronize
    - A long sequence of 0's or a long sequence of 1's
- Bit stuffing
  - Insert complementary bit after five equal bits
    - CAN 2.0A may add 3+n stuff bits (n is number of bytes)
    - CAN 2.0B may add 5+n stuff bits
  - Receiver has to un-stuff

Lecture 9

J. Valvano, A. Gerstlauer  
ECE445M/ECE380L.12

13

# TM4C123 CAN Modules

- 2 CAN Modules
  - Message RAM
    - 32 Msg. Objects
  - Message Objects
    - Tx Objects
      - One-time
      - Remote request
    - Rx Objects
      - Receive filters
      - Can be concatenated into FIFOs

Figure 17-1. CAN Controller Block Diagram

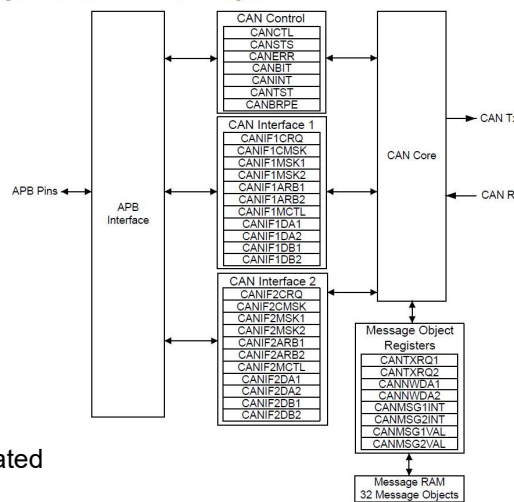

Lecture 9

J. Valvano, A. Gerstlauer  
ECE445M/ECE380L.12

14

# Microchip MCP2551

- CAN Transceiver

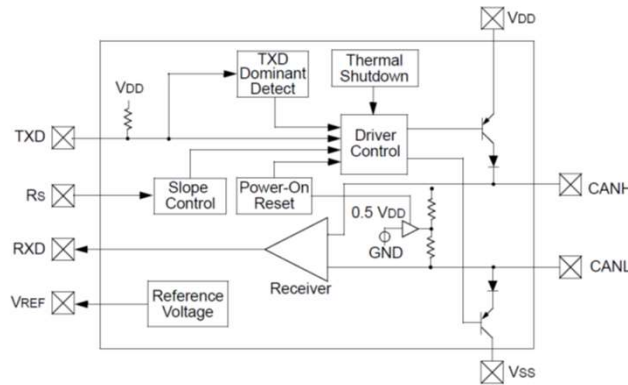

<http://www.microchip.com/wwwproducts/Devices.aspx?dDocName=en010405>  
<http://ww1.microchip.com/downloads/en/DeviceDoc/21667f.pdf>

Lecture 9

J. Valvano, A. Gerstlauer  
 ECE445M/ECE380L.12

15

# CAN Interfacing

There must be a 120Ω resistor on each end of the CAN cable, and no resistor on middle nodes.

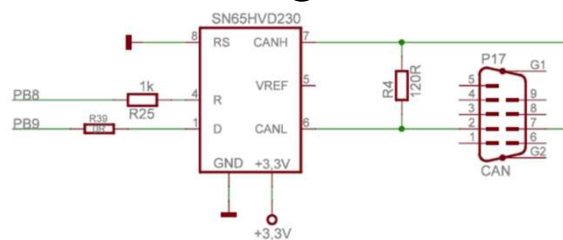

A transmission line if  $L > \lambda/4$ ,  $\lambda = v/f \approx v \tau$   
 Slew rate =  $25V/\mu s$ ,  $v = VF \cdot c = 2 \cdot 10^8$  m/s  
 $1V$  in  $40$  ns,  $\lambda = 2 \cdot 10^8$  m/s  $\cdot 40 \cdot 10^{-9}s = 8m$ ,  $\lambda/4 = 2m$

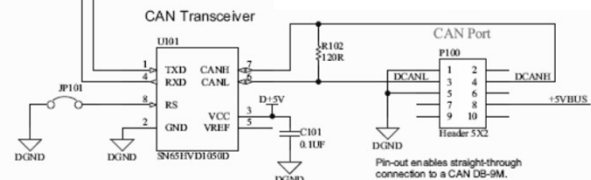
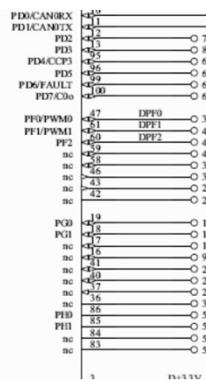

Lecture 9

J. Valvano, A. Gerstlauer  
 ECE445M/ECE380L.12

16



## Simple CAN Network

- TivaWare driver
  - CANInit
  - CANBitRateSet
  - CANEnable
  - CANIntEnable
  - CANMessageSet
  - CANIntStatus
  - CANStatusGet
  - CANMessageGet

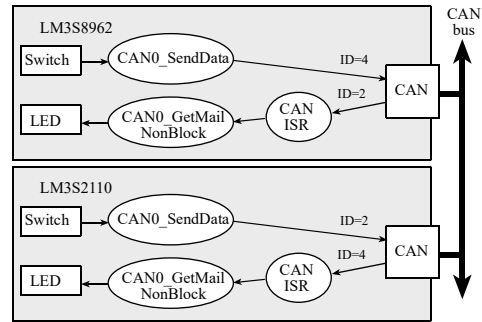

CAN\_4C123.zip

```
CANBitRateSet(CAN0_BASE, 8000000, CAN_BITRATE);
```

Lecture 9

J. Valvano, A. Gerstlauer  
ECE445M/ECE380L.12

17

## Logic Analyzer Traces

- Transmit Frame

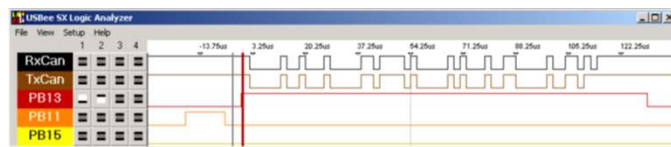

Why did it take 130µs to execute CAN\_Transmit?  
Why does the RxCan have more stuff than the TxCan?

- Receive Frame

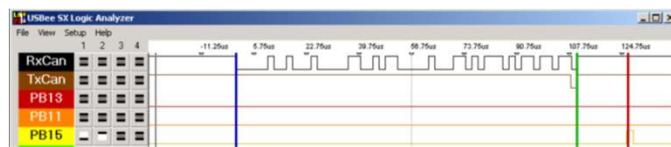

What is the total number of bits in this frame?  
Why did it take 110µs to complete an entire frame?  
What is that blimp on TxCan?  
Where is the end of the frame?  
What is the bandwidth?

Lecture 9

18

## Synchronization Issues

- How to connect transmitter/receiver threads?
  - How to start, handshake
  - Race conditions
- How to prevent streaming data from stalling?
  - Priority, buffer size

Lecture 9

J. Valvano, A. Gerstlauer  
ECE445M/ECE380L.12

19

## Ethernet

- Bus-based topology
  - Hub (repeater) or switch

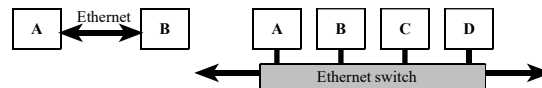

- Physical layer
  - Many variants evolved over the years

Pin	Color	Pair	Description
1	white/orange	2	TxData +
2	orange	2	TxData -
3	white/green	3	RecvData +
4	blue	1	Unused
5	white/blue	1	Unused
6	green	3	RecvData -
7	white/brown	4	Unused
8	brown	4	Unused

Table 9.2. Pin assignments on a 568-B Ethernet connector.

Lecture 9

J. Valvano, A. Gerstlauer  
ECE445M/ECE380L.12

20

# Ethernet Cabling

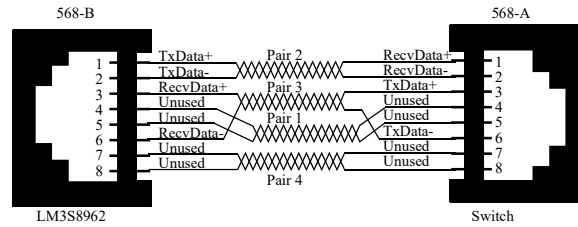

Figure 9.15. Ethernet cable between a microcontroller and a switch.

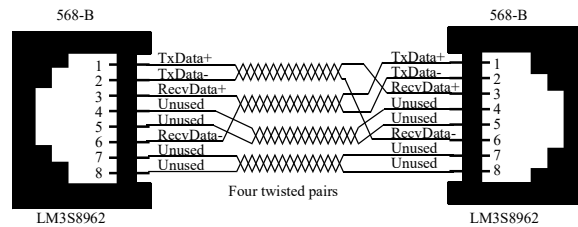

Figure 9.16. Ethernet cross-over cable between two microcontrollers.

Lecture 9

J. Valvano, A. Gerstlauer  
ECE445M/ECE380L.12

21

# Ethernet Protocol

Preamble	SFD	Destination Address	Source Address	Length/Type	Data	FCS
7 Bytes	1 Byte	6 Bytes	6 Bytes	2 Bytes	46 - 1500 Bytes	4 Bytes

- Ethernet Frame
  - Synchronization preamble (alternating 0/1)
  - Start frame delimiter (SFD)
  - Source & destination MAC addresses
  - Type/length field
  - Data
  - CRC frame check sequence (FCS)

Lecture 9

J. Valvano, A. Gerstlauer  
ECE445M/ECE380L.12

22

## Media Access Control (MAC)

- Distributed arbitration protocol
  - Obsolete if centralized switches are used
- Carrier Sense Multiple Access with Collision Detection (CSMA/CD)
  - Sense free carrier before sending
  - Sense while transmitting to detect collision
    - If collision, send jam signal
  - Binary exponential backoff
    - Increment collision counter  $c$
    - Wait random period in range  $0 \dots 2^c - 1$

Lecture 9

J. Valvano, A. Gerstlauer  
ECE445M/ECE380L.12

23

## ISO/OSI 7-Layer Model

- Abstraction
  - International Standards Organization (ISO)
  - Open Systems Interconnection (OSI)

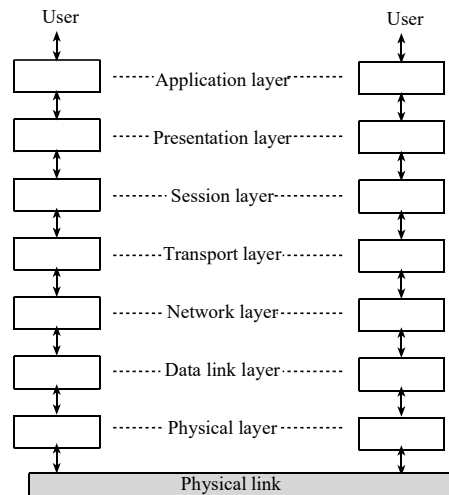

Lecture 9

J. Valvano, A. Gerstlauer  
ECE445M/ECE380L.12

24

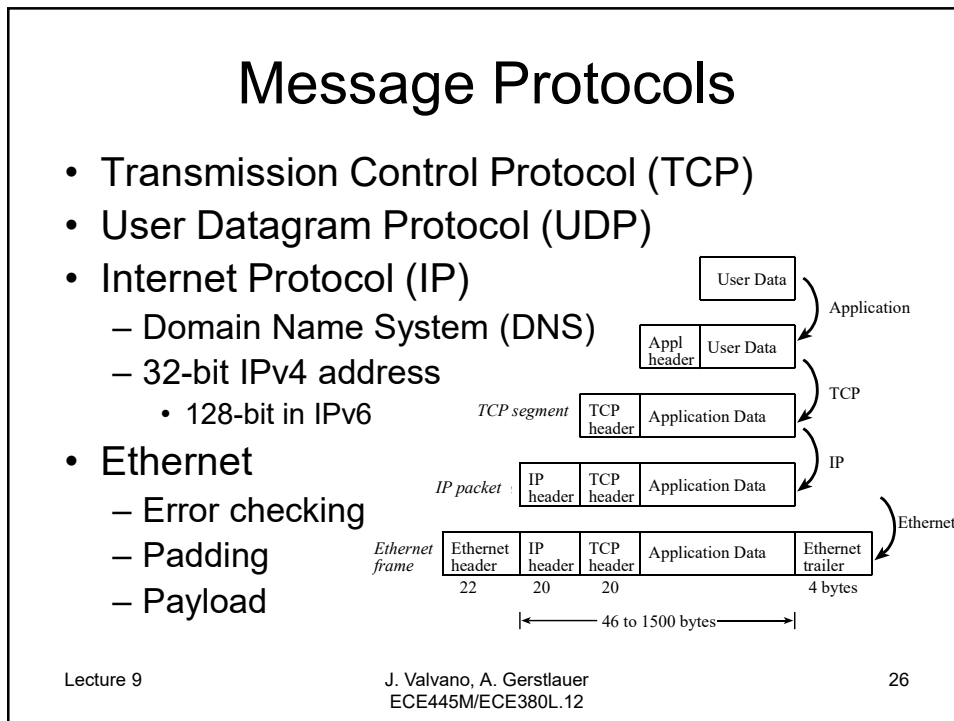
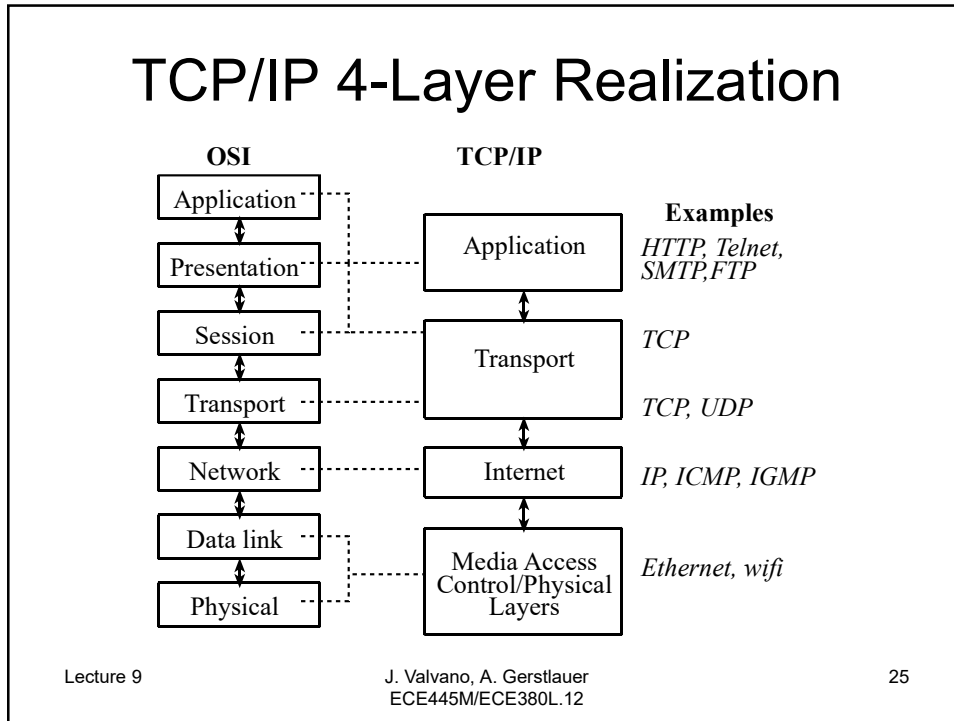

# Internet Protocol (IP)

- IP packet (IPv4)

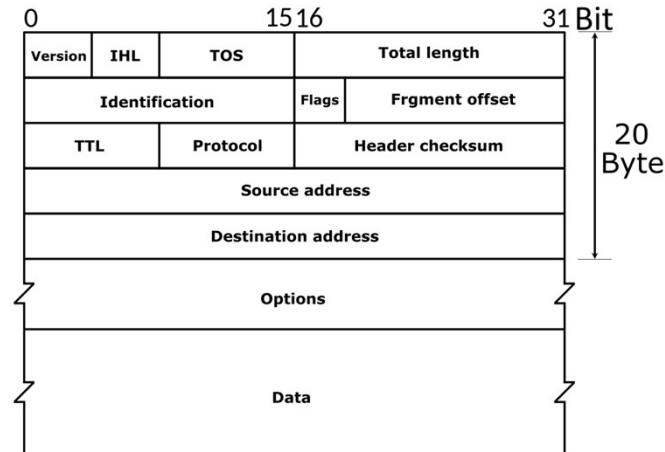

Lecture 9

J. Valvano, A. Gerstlauer  
ECE445M/ECE380L.12

Source: Wikipedia

27

# UDP and TCP

- UDP single datagram (connectionless)
  - 8-byte header

Source port: 16-bit number of the process that sent the packet, could be zero
Destination port: 16-bit number of the process to receive the packet.
Length: 16-bit number specifying the size in bytes of the data to follow
Checksum: 16-bit modulo addition of all data, UDP header, and IP header

- TCP session stream (error & flow control)
  - 20-byte header

Source port: 16-bit number of the process that sent the packet, could be zero
Destination port: 16-bit number of the process to receive the packet.
Sequence number: 32-bit number defining the position of this data
Acknowledgement: 32-bit number of the next data expected to be received
Hlen: 4-bit field of the header size (including options) divided by 4
Flags: 6-bit field with FIN, SYN, RST, PSH, ACK, and URG
Window: 16-bit number specifying the number of bytes the receiver can accept
Checksum: 16-bit modulo addition of all data, TCP header, and IP header
Urgent pointer: 16-bit field pointing to a place in the stream urgently needed

Lecture 9

J. Valvano, A. Gerstlauer  
ECE445M/ECE380L.12

28

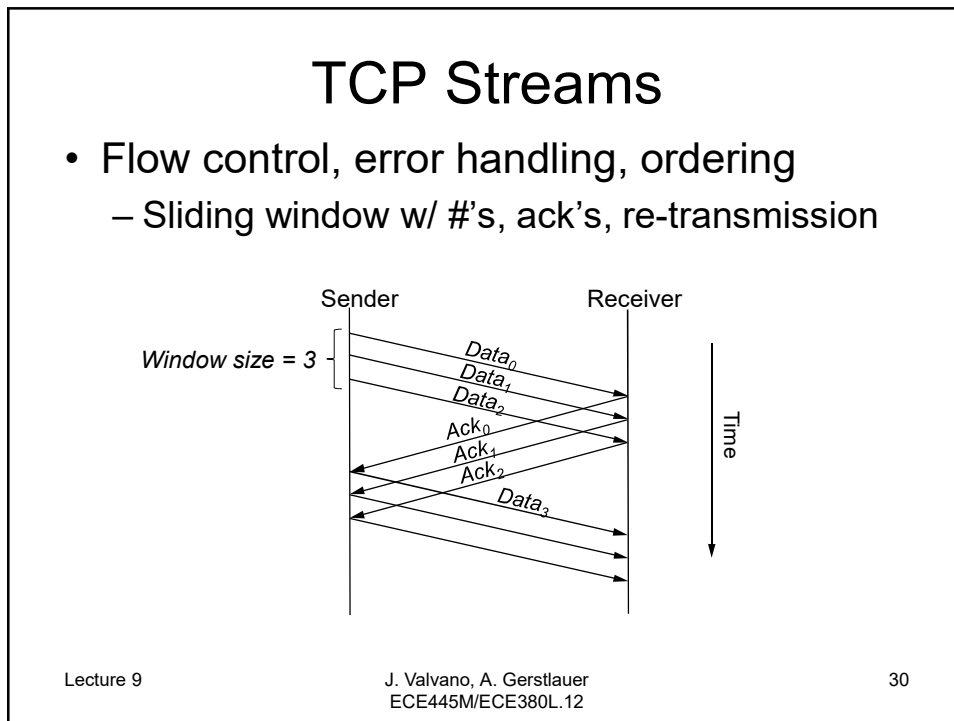
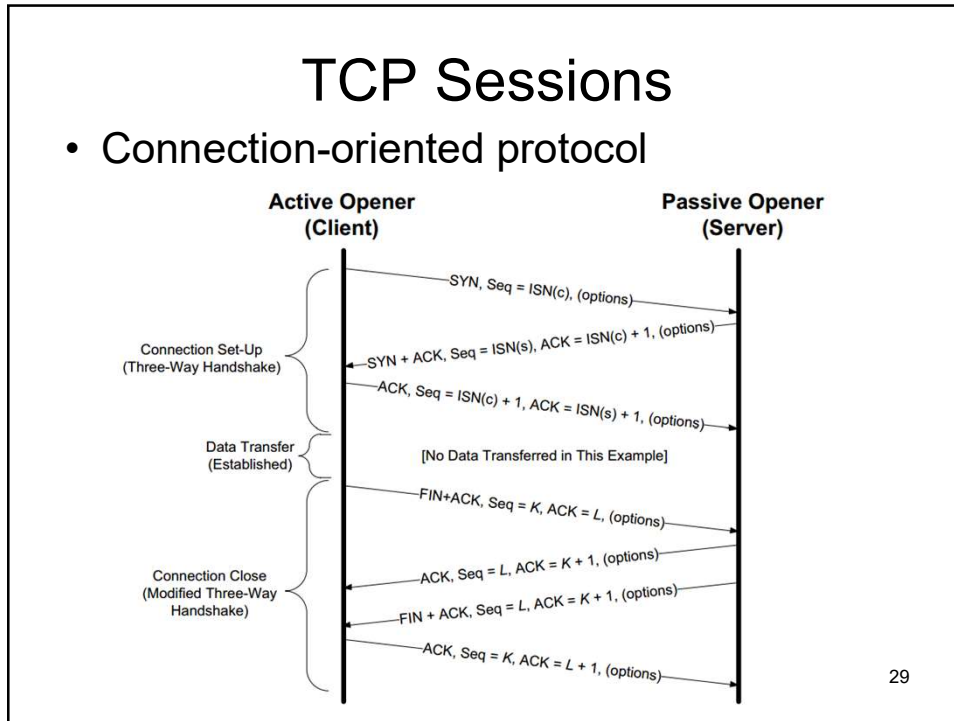

# Application Protocols

- Client/server models
  - HTTP (web), FTP, Telnet, SSH, ...
- Providing (device) services over the web
  - XML-based protocol: SOAP, WSDL
  - Simpler REST-ful API styles
    - Request encoded in URL
    - Return data using XML, JSON, ... formats

Lecture 9

J. Valvano, A. Gerstlauer  
ECE445M/ECE380L.12

31

# Embedded Internet

- Internet of Things (IoT)

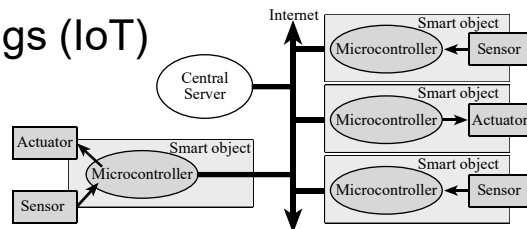

- Internet standardization: TCP/IP Protocol

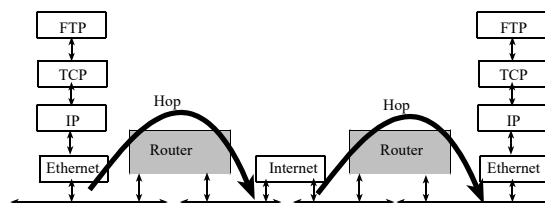

Reference: W. Richard Stevens TCP/IP Illustrated, Volume 1: The Protocols

Lecture 9

J. Valvano, A. Gerstlauer  
ECE445M/ECE380L.12

32



## Networking Summary

- Standardization is key
  - Communication standards
  - Across levels/layers
    - Physical, OS, application
  
- IoT is an open playing field
  - Internet as well-established foundation
  - Application-level standardization?
    - Embedded device-to-device interactions