

ECE445M/ECE380L.12

Embedded and Real-Time Systems/ Real-Time Operating Systems

Lecture 11: Memory Protection, Virtual Memory, Paging

References: T. Anderson, M. Dahlin, "Operating Systems: Principles and Practice"
R. & A. Arpaci-Dusseau, "Operating Systems: Three Easy Pieces", <http://ostep.org>

Lecture 11

J. Valvano, A. Gerstlauer
ECE445M/ECE380L.12

1

Recap: Memory Management

- Sharing
 - Per-thread: stack
 - Per-program/-process: code, data
- Allocation
 - Static, permanent
 - OS code & data
 - Dynamic, temporary
 - Stacks & heaps, process code & data
- Protection
 - Access control

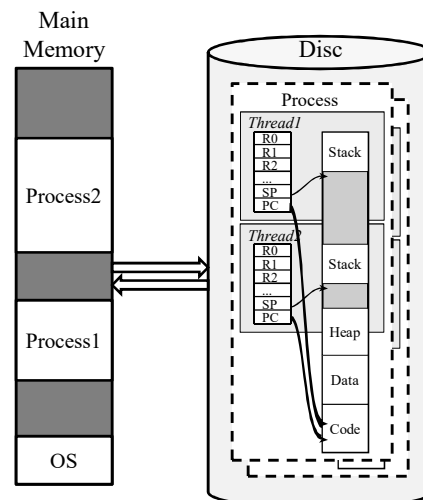

Lecture 11

J. Valvano, A. Gerstlauer
ECE445M/ECE380L.12

2

Memory Protection

- Divide memory into regions
 - Allocated heap blocks
 - Thread/process data & code segments
- Define access control per region
 - Read-only/read-write
 - Execute/no-execute
- Enforce access control in hardware
 - On every memory access (load/store)
 - Permission fault exception

Lecture 11

J. Valvano, A. Gerstlauer
ECE445M/ECE380L.12

3

TM4C123 Memory Protection

- Memory Protection Unit (MPU)
 - 8 separate memory regions

MPU Region Base Address (MPUBASE)

Base 0xE000.E000
Offset 0xD9C
Type R/W, reset 0x0000.0000

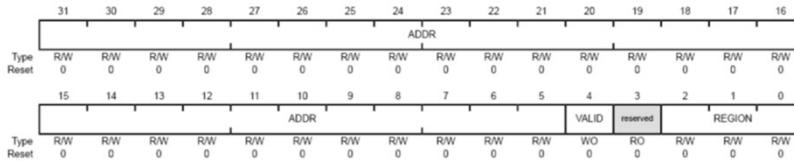

Bit/Field	Name	Type	Reset	Description
31:5	ADDR	R/W	0x0000.0000	Base Address Mask Bits 31:N in this field contain the region base address. The value of N depends on the region size, as shown above. The remaining bits (N-1):5 are reserved. Software should not rely on the value of a reserved bit. To provide compatibility with future products, the value of a reserved bit should be preserved across a read-modify-write operation.

Lecture 11

J. Valvano, A. Gerstlauer
ECE445M/ECE380L.12

4

Thread-Protected Mode

- Only current thread has memory access
 - Code
 - Data/heap, stack
 - OS kernel traps
- On context switch
 - Re-assign MPU permissions
 - Extra overhead

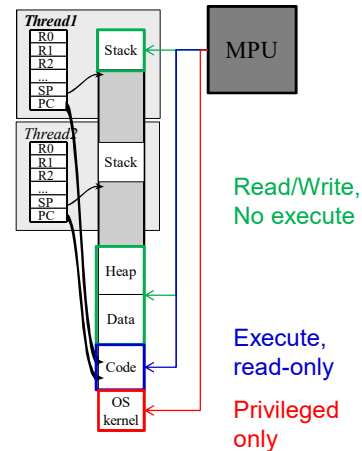

Lecture 11

J. Valvano, A. Gerstlauer
ECE445M/ECE380L.12

7

μCOS Thread Groups

- Group of threads protected jointly
 - Called “process” in μCOS-II
 - Group-local shared memory region
- Inter-group communication
 - Through OS kernel
 - Special shared memory areas

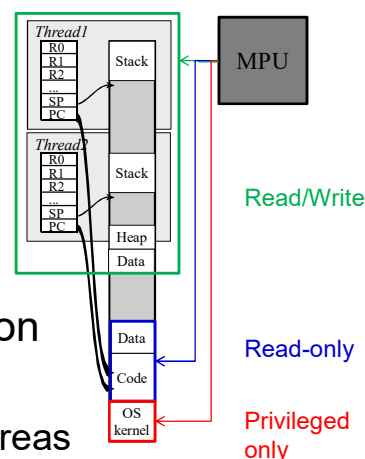

Lecture 11

J. Valvano, A. Gerstlauer
ECE445M/ECE380L.12

8

Multi-Processing

- Process
 - Whole program in execution
 - Code, data, heap
 - One or more threads
- Multi-processing
 - Multiple processes/programs in main memory
 - OS schedules processes & threads
 - Process-level protection

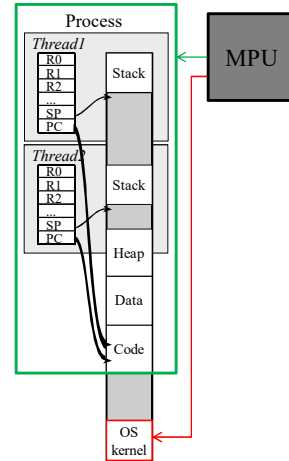

Lecture 11

J. Valvano, A. Gerstlauer
ECE445M/ECE380L.12

9

Recap: Processes

- OS manages processes
 - CPU scheduling
 - Code/data memory
- Independent programs
 - Separately compiled
 - Logical address space
- Brought in/out of memory
 - On load/exit, swapped in/out by OS
 - Contiguous or non-contiguous

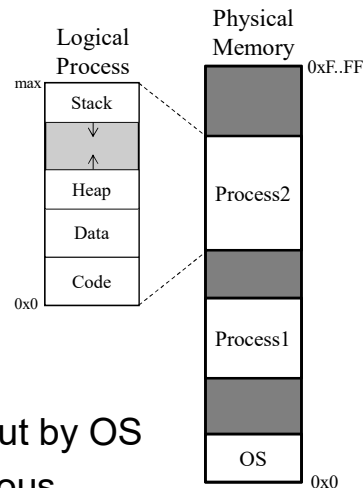

Lecture 7

J. Valvano, A. Gerstlauer
ECE445M/ECE380L.12

10

Recap: Address Translation

- Virtual addresses in process
 - Compiler generated programs on disk
 - Location of & references to code and data
- Physical addresses in main memory
 - Need to map virtual into physical addresses
 - Compile time: generate for known location
 - Load time: relocation by OS, dynamic linking
 - Run time: software or hardware, virtual memory

Lecture 11

J. Valvano, A. Gerstlauer
ECE445M/ECE380L.12

11

Memory Management Unit (MMU)

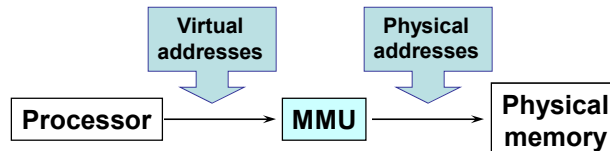

- Fast & efficient address translation
 - Hardware supported, at run-time
 - Start with old, simple ways
 - Progress to current techniques

Lecture 11

J. Valvano, A. Gerstlauer
ECE445M/ECE380L.12Source: G. M. Voelker, UCSD,
CSE 120 – Lecture 9 – Memory

12

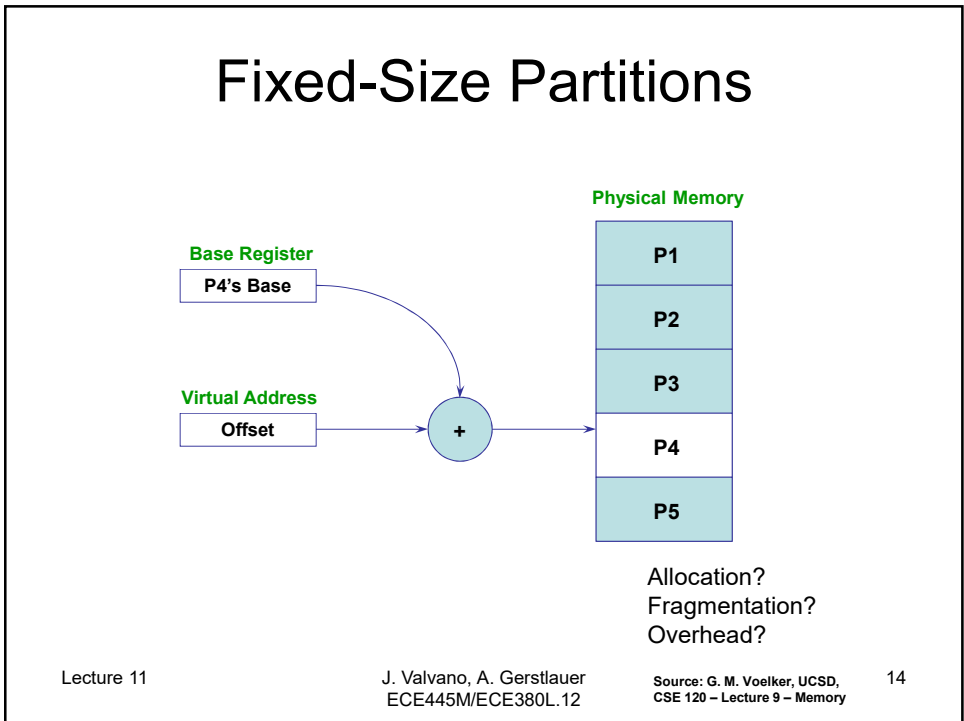
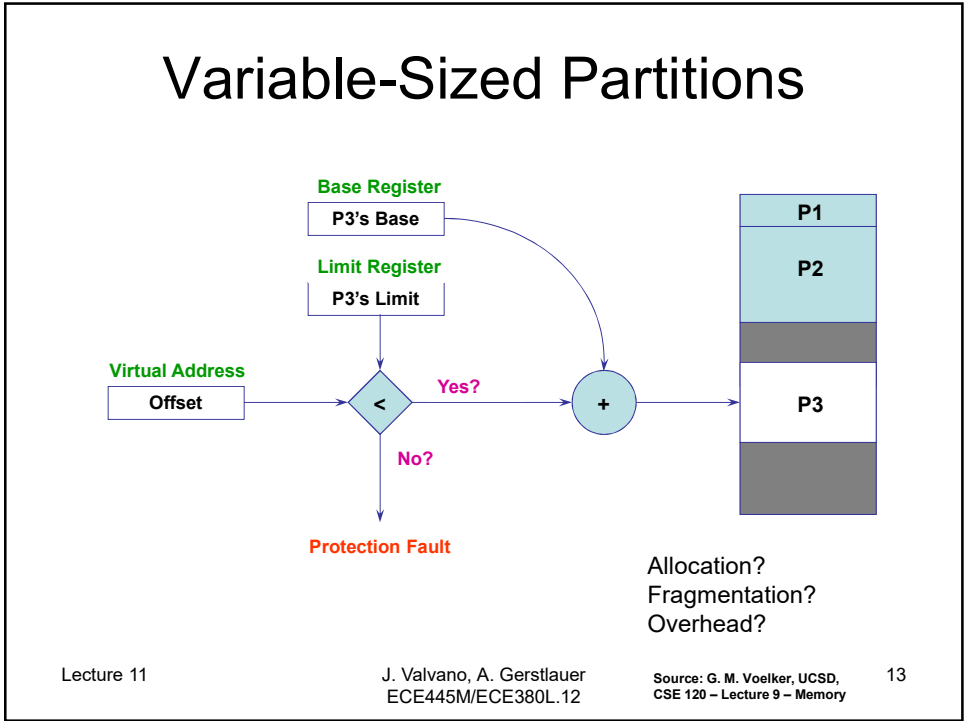

Segmentation

- Natural extension of partitions
 - Partitions = 1 segment/process
 - Segmentation = many segments/process
- Partition memory into logically related units
 - Code, data, stack, heap, etc.
 - Virtual addresses become <segment #, offset>
 - Units of memory from programmer's perspective
- Hardware support
 - Multiple base/limit pairs, one per segment (segment table)
 - Segments named by #, used to index into table

Lecture 11

J. Valvano, A. Gerstlauer
ECE445M/ECE380L.12Source: G. M. Voelker, UCSD,
CSE 120 – Lecture 9 – Memory

15

Segmented Address Space

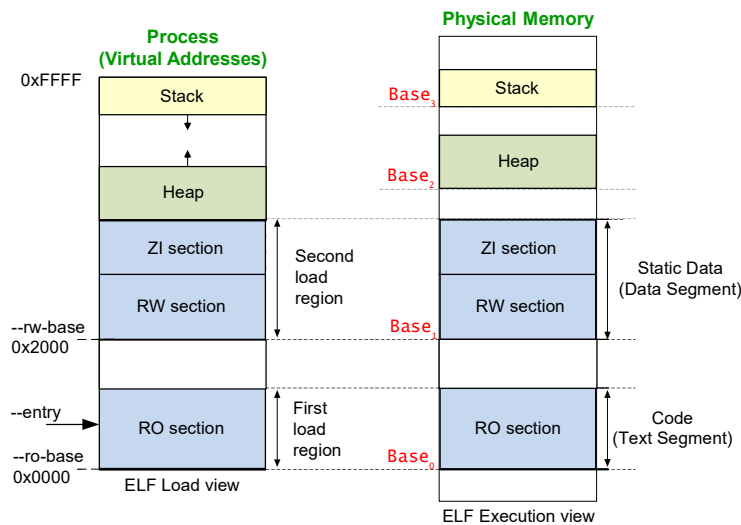

Lecture 11

J. Valvano, A. Gerstlauer
ECE445M/ECE380L.12

16

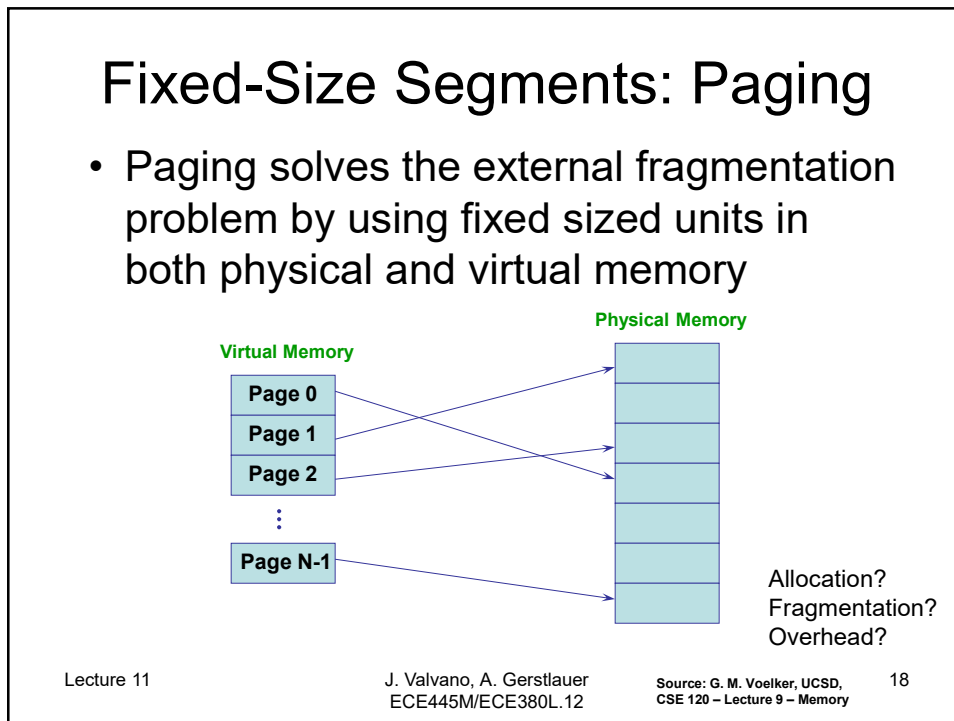
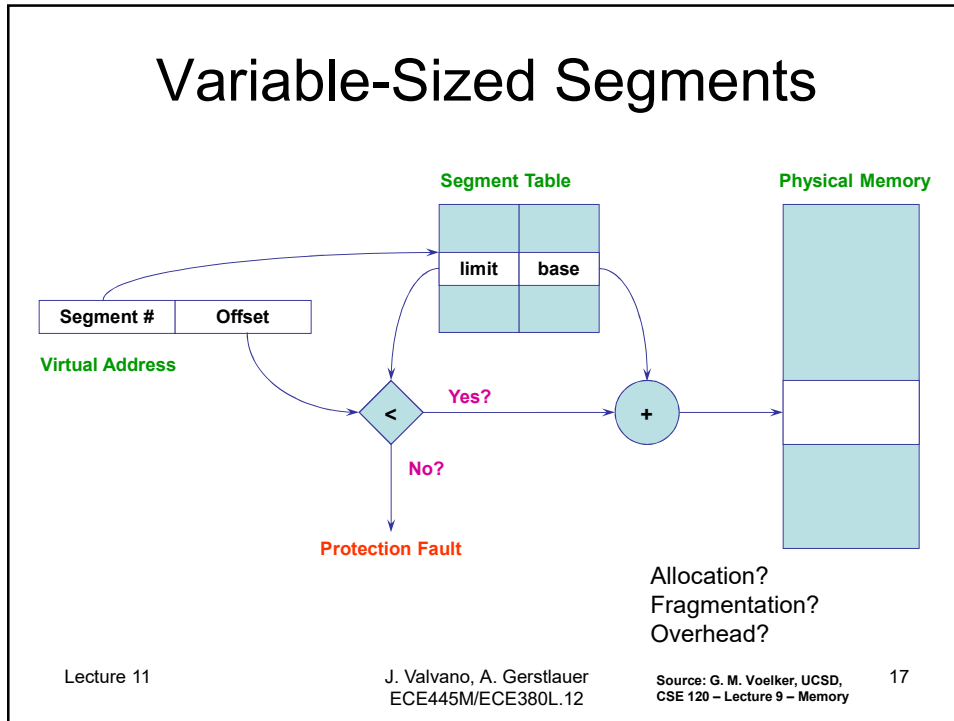

Virtual Memory

- Programmers (and processes) view memory as one contiguous address space
 - From 0 through N
 - Virtual address space (VAS)
- In reality, pages are scattered throughout physical storage
- The mapping is invisible to the program
- Protection is provided because a program cannot reference memory outside of its VAS
 - The address “0x1000” maps to different physical addresses in different processes

Lecture 11

J. Valvano, A. Gerstlauer
ECE445M/ECE380L.12Source: G. M. Voelker, UCSD,
CSE 120 – Lecture 9 – Memory

19

Demand Paging / Swapping

- Pages can be moved between memory and disk
 - Use disk to provide more virtual than physical memory
- OS uses main memory as a page cache of all the data allocated by processes in the system
 - Initially, pages are allocated from memory
 - When memory fills up, allocating a page in memory requires some other page to be evicted from memory
 - Why physical memory pages are called “frames”
 - Evicted pages go to disk
 - Where? The swap file/backing store
 - The movement of pages between memory and disk is done by the OS, and is transparent to the application
 - But: expensive!

Lecture 11

J. Valvano, A. Gerstlauer
ECE445M/ECE380L.12Source: G. M. Voelker, UCSD,
CSE 120 – Lecture 10 – Paging

20

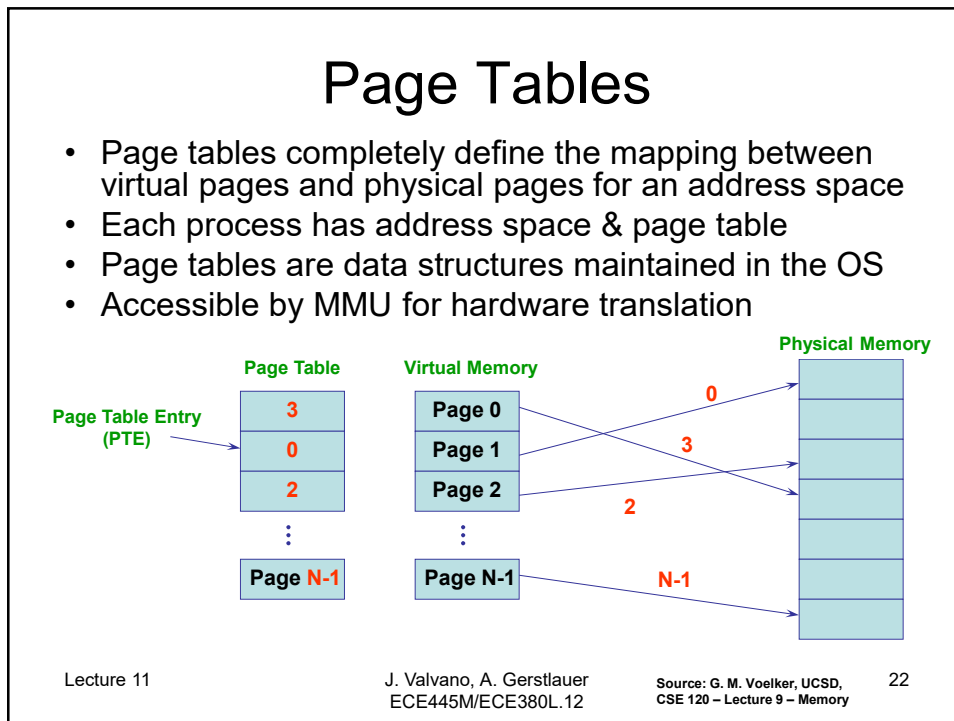
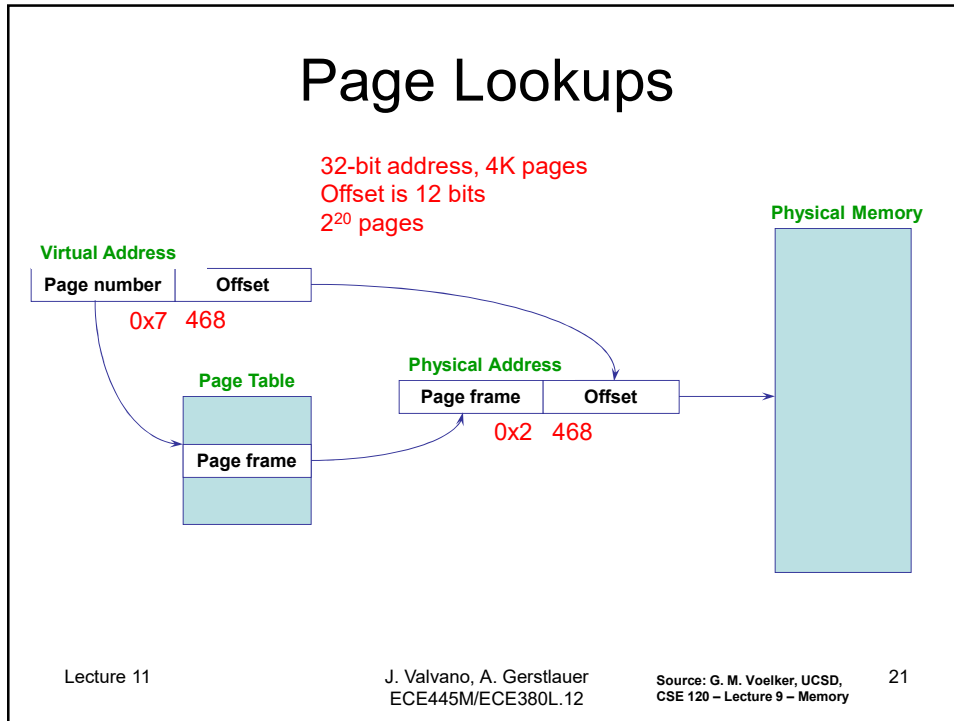

Page Table Entries (PTEs)



- Page table entries control mapping
 - The **Modify** bit says whether or not the page has been written
 - It is set when a write to the page occurs
 - The **Reference** bit says whether the page has been accessed
 - It is set when a read or write to the page occurs
 - The **Valid** bit says whether or not the PTE can be used
 - It is checked each time the virtual address is used, set when page is in memory
 - The **Protection** bits say what operations are allowed on page
 - Read, write, execute
 - The **page frame number** (PFN) determines physical page

Lecture 11

J. Valvano, A. Gerstlauer
ECE445M/ECE380L.12Source: G. M. Voelker, UCSD,
CSE 120 – Lecture 9 – Memory

23

Segmentation and Paging

- Can combine segmentation and paging
 - The x86 supports segments and paging
- Use segments to manage logically related units
 - Module, procedure, stack, file, data, etc.
 - Segments vary in size, but usually large (>1 page)
- Pages to partition segments into fixed size chunks
 - Segments easier to manage within physical memory
 - Segments become “pageable” – rather than moving segments into and out of memory, just move page portions of segment
 - Need to allocate page table entries only for those pieces of the segments that have themselves been allocated
- Tends to be complex...

Lecture 11

J. Valvano, A. Gerstlauer
ECE445M/ECE380L.12Source: G. M. Voelker, UCSD,
CSE 120 – Lecture 9 – Memory

24

Paging Limitations

- Can still have internal fragmentation
 - Process may not use memory in multiples of a page
- Memory reference overhead
 - 2 references per address lookup (page table, then memory)
 - Solution – use a hardware cache of lookups (more later)
- Memory required to hold page table can be significant
 - Need one PTE per page
 - 32 bit address space w/ 4KB pages = 2^{20} PTEs
 - 4 bytes/PTE = 4MB/page table
 - 25 processes = 100MB just for page tables!
 - How to reduce page size?
- How do we only map what is being used?
 - Dynamically extending page table, but fragmentation

Lecture 11

J. Valvano, A. Gerstlauer
ECE445M/ECE380L.12

Source: G. M. Voelker, UCSD,
CSE 120 – Lecture 9 – Memory

25

Two-Level Page Tables

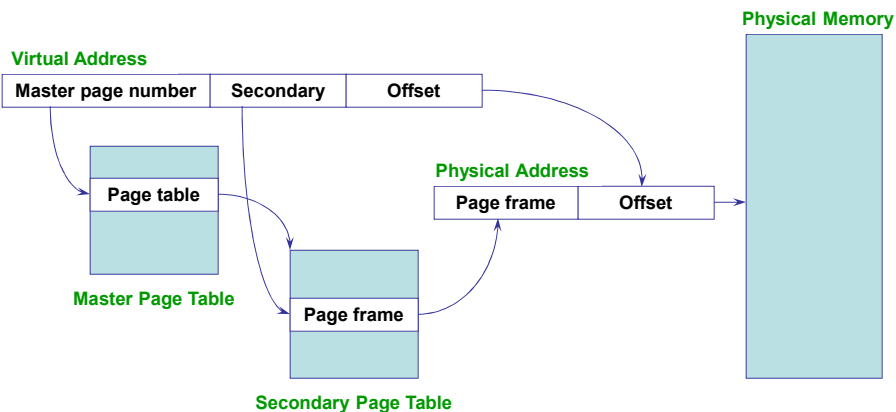

Lecture 11

J. Valvano, A. Gerstlauer
ECE445M/ECE380L.12

Source: G. M. Voelker, UCSD,
CSE 120 – Lecture 10 – Paging

26

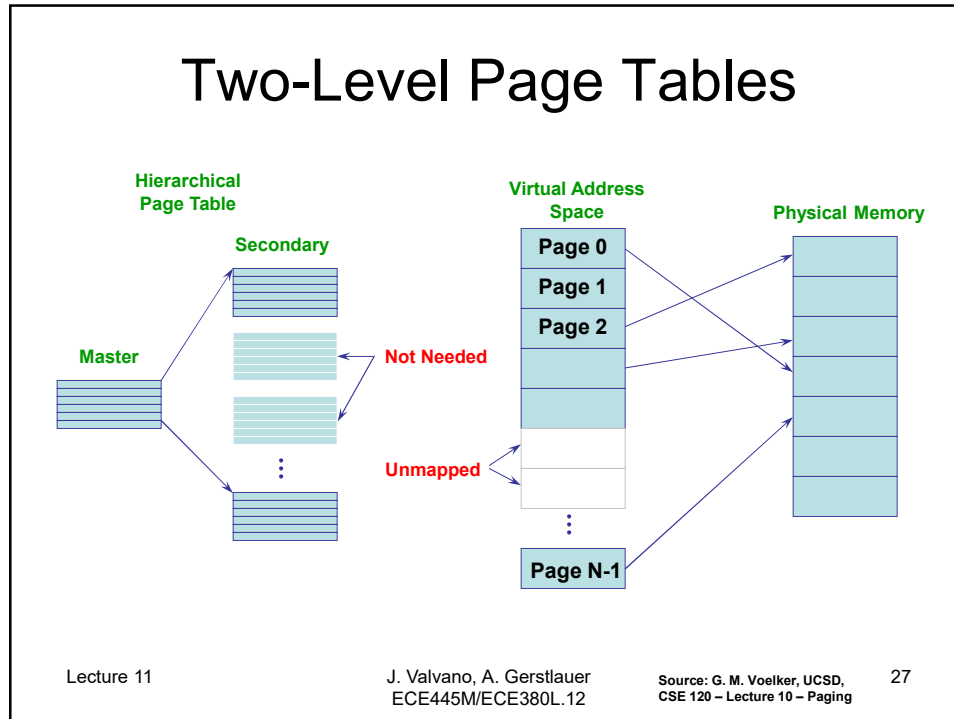

Efficient Translations

- Original page table scheme already doubled the cost of doing memory lookups
 - Lookup into page table + fetch the data
- Two-level page tables triple the cost!
 - 2x lookups into page tables, a third to fetch the data
 - And this assumes the page table is in memory
- How can we use paging but also have lookups cost about the same as fetching from memory?
 - Cache translations in hardware
 - Translation Lookaside Buffer (TLB)
 - TLB managed by Memory Management Unit (MMU)

Lecture 11

J. Valvano, A. Gerstlauer
ECE445M/ECE380L.12Source: G. M. Voelker, UCSD,
CSE 120 – Lecture 10 – Paging

28

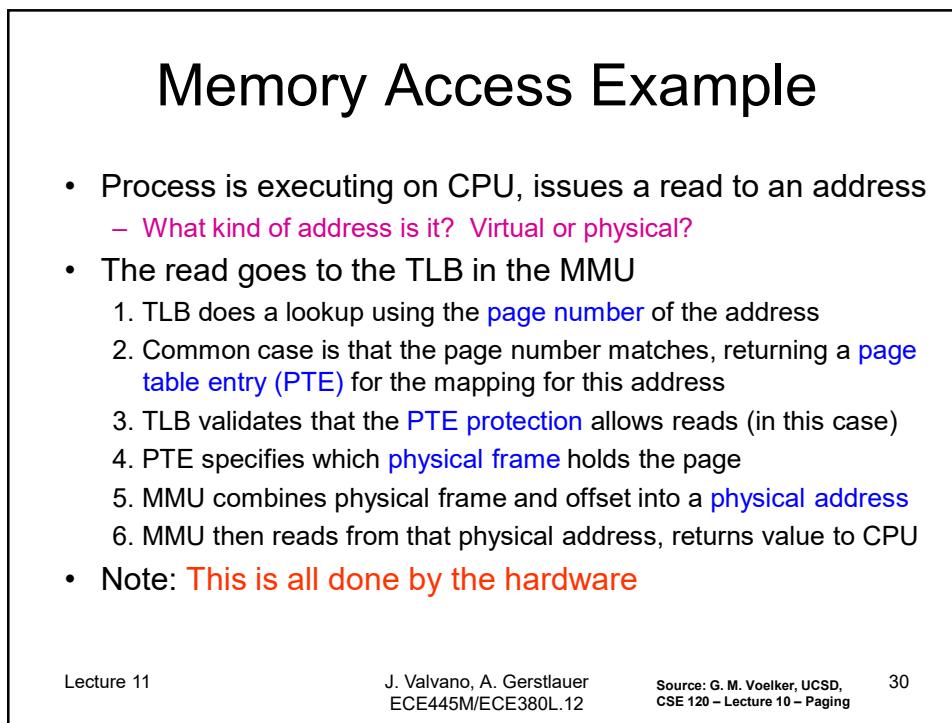
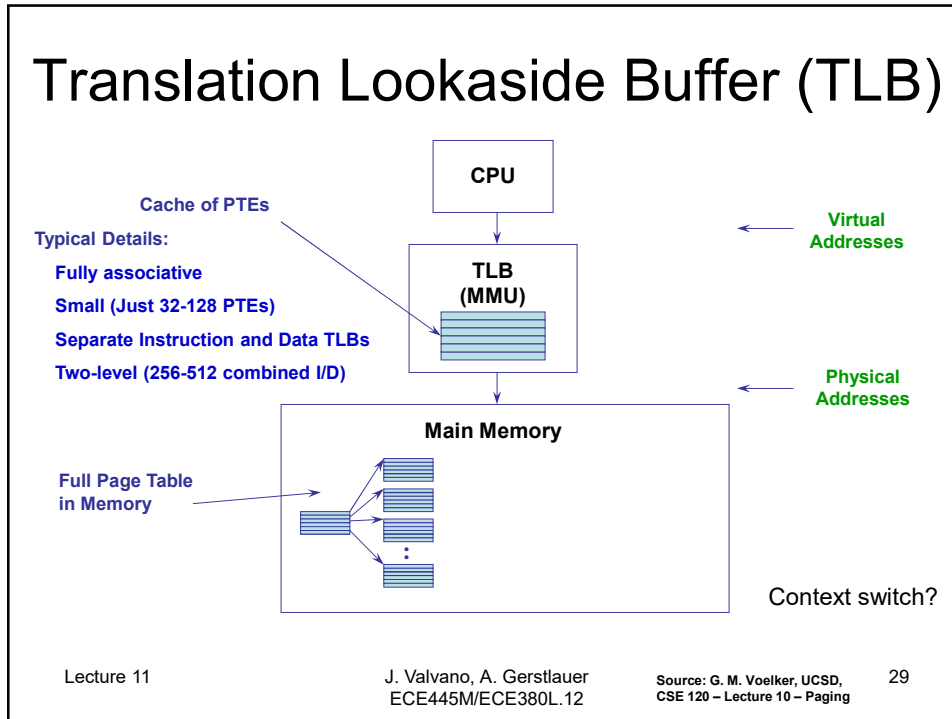

TLB Miss

- If the TLB does not have mapping:
 1. MMU loads PTE from page table in memory
 - Hardware managed TLB [x86]
 - OS has already set up the page tables so that the hardware can access it directly, otherwise not involved
 2. Trap to the OS
 - Software/OS managed TLB [MIPS, Alpha, Sparc, PowerPC]
 - OS does lookup in page table, loads PTE into TLB
 - OS returns from exception, TLB continues
- Replace existing PTE in TLB
 - Done in hardware, e.g. least recently used
 - At this point, PTE for the address in the TLB

Lecture 11

J. Valvano, A. Gerstlauer
ECE445M/ECE380L.12Source: G. M. Voelker, UCSD,
CSE 120 – Lecture 10 – Paging

31

Demand Paging / Swapping

- Pages can be moved between memory and disk
 - Use disk to provide more virtual than physical memory
- OS uses main memory as a page cache of all the data allocated by processes in the system
 - Initially, pages are allocated from memory
 - When memory fills up, allocating a page in memory requires some other page to be evicted from memory
 - Why physical memory pages are called “frames”
 - Evicted pages go to disk
 - Where? The swap file/backing store
 - The movement of pages between memory and disk is done by the OS, and is transparent to the application
 - But: expensive!

Lecture 11

J. Valvano, A. Gerstlauer
ECE445M/ECE380L.12Source: G. M. Voelker, UCSD,
CSE 120 – Lecture 10 – Paging

32

Page Fault

- PTE can indicate a protection fault
 - Read/write/execute – operation not permitted
 - Invalid – virtual page not allocated/not in memory
- TLB traps to the OS (OS takes over)
 - R/W/E violation
 - OS sends fault back up to process, or intervenes
 - Invalid
 - Virtual page not allocated in address space
 - OS sends fault to process (e.g., segmentation fault)
 - Page not in physical memory
 - OS allocates frame, reads from disk (swap space)
 - Maps PTE to physical frame, update TLB

Lecture 11

J. Valvano, A. Gerstlauer
ECE445M/ECE380L.12Source: G. M. Voelker, UCSD,
CSE 120 – Lecture 10 – Paging

33

Page Replacement

- Which page to evict on invalid page fault?
 - Page replacement policies
 - Avoid thrashing (if possible)
- Exploit locality
 - Temporal and spatial locality
 - Working set (pages most recently referenced)
 - FIFO, Least Recently Used (LRU), ...
- Dirty vs. clean pages (marked in PTE)
 - Only write back dirty pages to disk

Lecture 11

J. Valvano, A. Gerstlauer
ECE445M/ECE380L.12Source: G. M. Voelker, UCSD,
CSE 120 – Lecture 11 – Page Replacement

34

Addressing Page Tables

- Where do we store page tables?
 - Physical memory
 - Easy to address, no translation required
 - But, allocated tables consume memory for lifetime of VAS
 - Virtual memory (OS virtual address space)
 - Cold (unused) page table pages can be paged out to disk
 - But, addressing page tables requires translation
 - How do we stop recursion?
 - Do not page the outer page table (called **wiring**)
 - If we're going to page the page tables, might as well page the entire OS address space, too
 - Need to wire special code and data (fault, int handlers)

Lecture 11

J. Valvano, A. Gerstlauer
ECE445M/ECE380L.12Source: G. M. Voelker, UCSD,
CSE 120 – Lecture 10 – Paging

35

Advanced Functionality

- Shared memory
 - PTEs of two processes point to same page
- Copy on Write (**fork()** a process)
 - Copy only page table to clone process
 - Copy memory frame only on first write
- Mapped files
 - Map pages from file on disk into memory

Lecture 11

J. Valvano, A. Gerstlauer
ECE445M/ECE380L.12Source: G. M. Voelker, UCSD,
CSE 120 – Lecture 10 – Paging

36

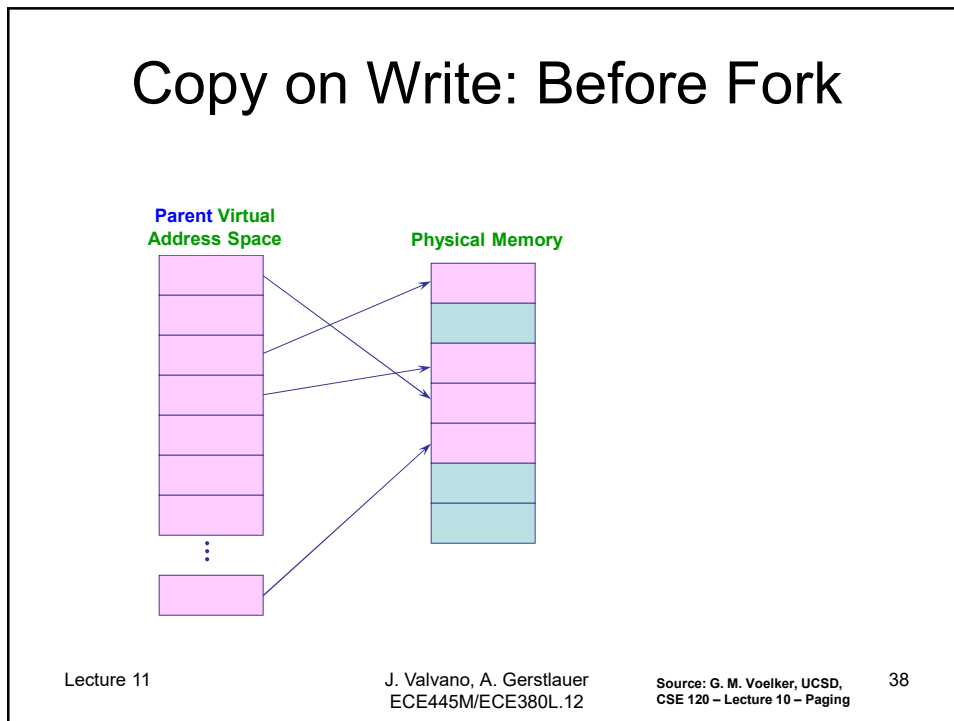
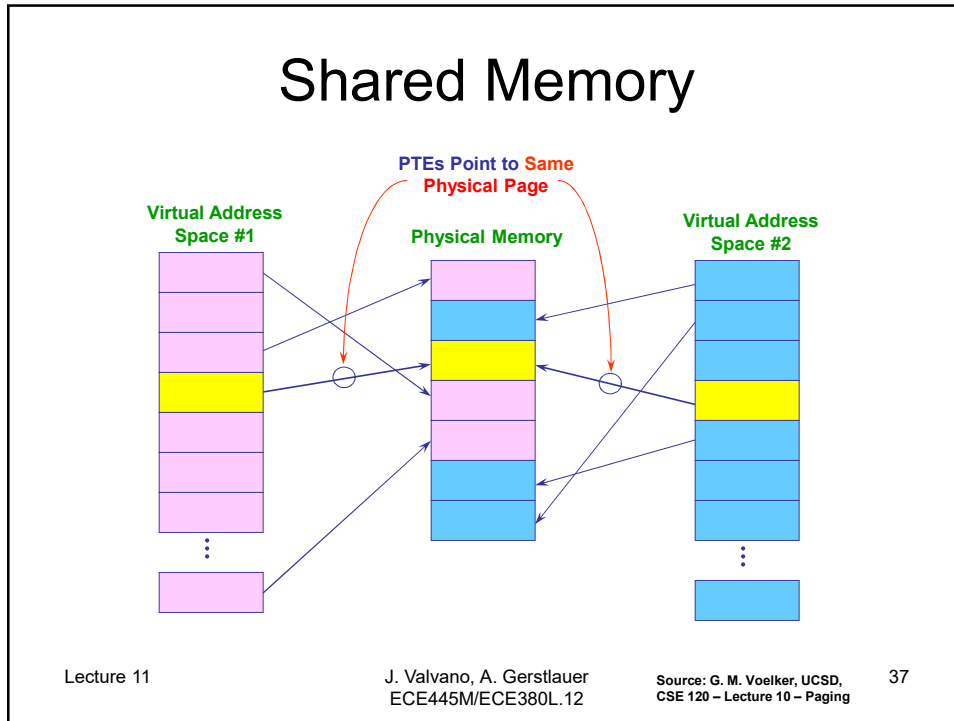

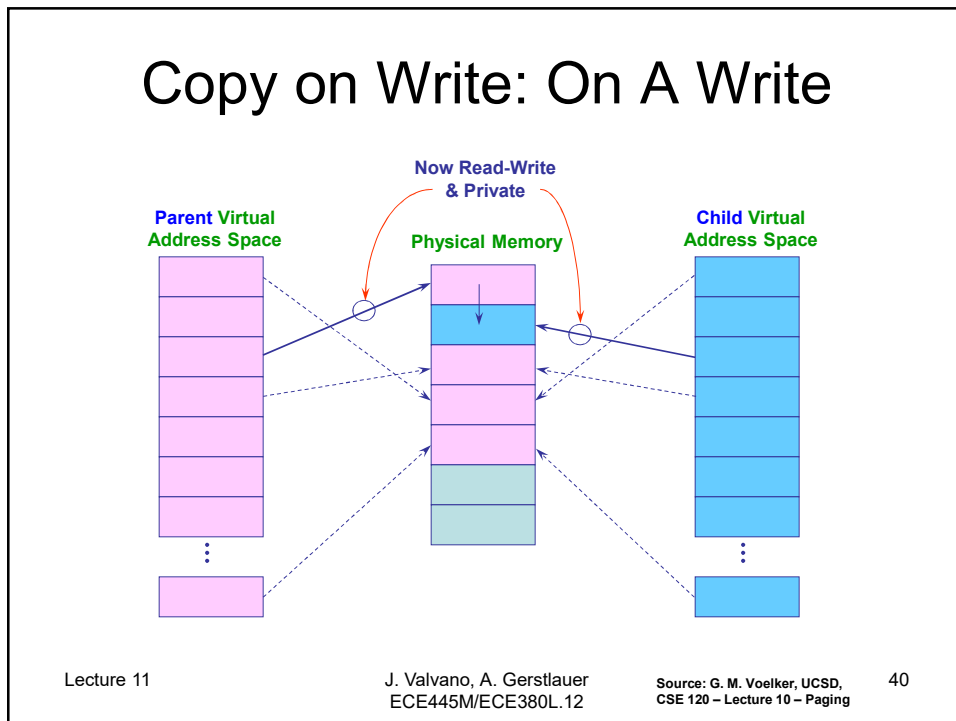
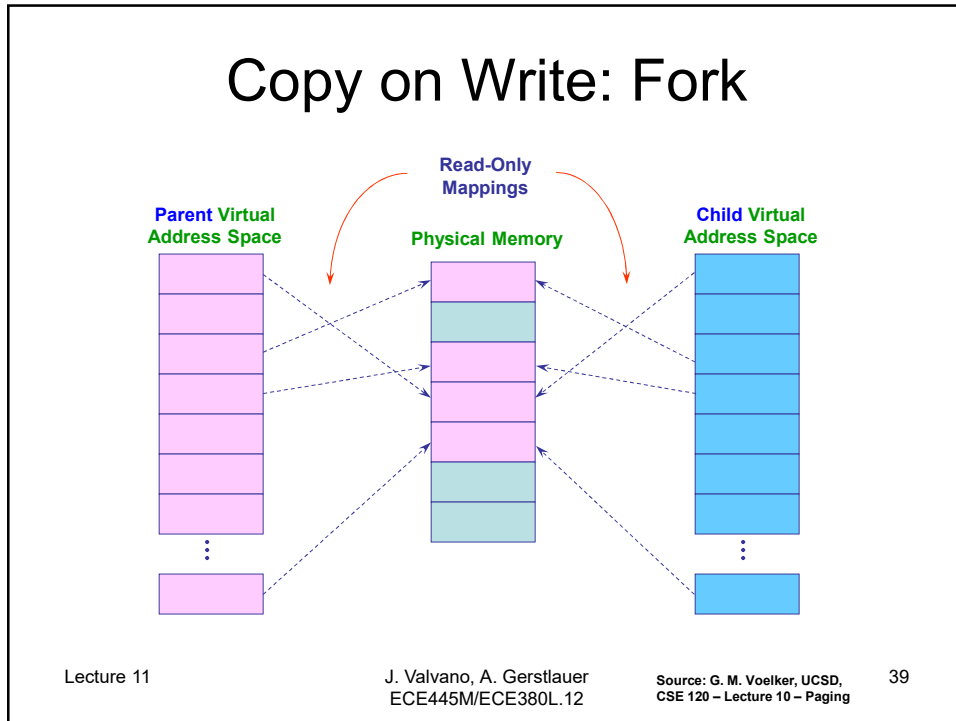

Mapped Files

Virtual Address Space

Mapped File

PTEs initially invalid
Read into memory on page fault
Write back when dirty on eviction

Similar approach used by OS when loading process/program from disk (copy to swap space, then map)

- Bind file to memory region
 - Linux: `mmap ()`
- File acts as backup store
 - Instead of swap space

Lecture 11 J. Valvano, A. Gerstlauer
ECE445M/ECE380L.12 Source: G. M. Voelker, UCSD,
CSE 120 – Lecture 10 – Paging 41

Memory Management Summary

- Often not used in embedded devices
 - Overhead
 - Page table storage, Context switching
 - Unpredictable timing
 - TLB misses, Page faults
- Static memory management
 - Static data allocation, no heap
 - No MMU/paging
 - Compile/load time relocation (optionally segmented)
 - Hardware support for protection & translation
 - Swapping under program control (overlays)

Lecture 11 J. Valvano, A. Gerstlauer
ECE445M/ECE380L.12 42